

STL362DQ



Familie	Vaatwasser
Commerciële breedte	60 cm
Nishoogte	82 cm
Installatie	Volledig geïntegreerd
Deur paneel	Niet meegeleverd
Aantal korven	3, Flexi
Motor	Inverter 2.0
EAN-code	8017709337353



Programma's / functies

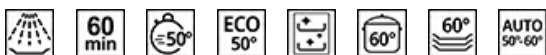

Aantal programma's	7+1	Eco	Ja
Wastemperatuur	50, 60 °C	Zelf reinigen	Ja
Weken	Ja	Intensief 60°	Ja
Snel - Volledig 60'	Ja	Mix 60°	Ja
Snel 50°	Ja	Auto 50°-60°	Ja

Opties



Delay timer optie	Tot 24 uur, i.c.m. automatisch spoelen	Crystal option	Ja
Extreme option	Ja		

Korven

Kleur korven	Grijs	Maximum afmetingen bord dat in bovenste korf kan worden geladen	19,0 cm
Kleur korfcomponenten	Grijs	Onderkorf	2 inklapbare rekken
Handgreep	Op onder- en bovenkorf	Maximum afmetingen bord dat in onderste korf kan worden geladen	31.0 cm
Bovenkorf	Met 1 opvouwbaar rek		
In hoogte verstelbare bovenkorf	On two levels (4 cm)	Kleur binnenonderdelen	Blauw

Technische specificaties



Breedte product	596 mm	Watertoevoer	Enkel; koud en warm water tot 60°C - energiebesparing tot 35%
Diepte product	550 mm	Maximale waterhardheid	90°FH; 50°dH
Type display	3 cijfers	Droogstelsysteem	Natuurlijk condensor drogen met Dry Assist + automatische deuropeningssysteem aan het einde van de cyclus
Hoogte product	818 mm	Stoombeveiliging	Van kunststof
Bediening	Elektronisch	Materiaal kuip	Roestvrij staal
Display	Instelling Delay timer, Programma duur indicator, Resttijd indicatie	Filter	Roestvrij staal
Grafische weergave programma's	Symbolen	Verborgen verwarmingselement	Ja
Aan/uit indicator	Ja	Scharnieren	Self balancing, Sliding, FLEXIFIT
Zout indicator	Indicator (lampje)	Min. en max. frontaal paneelgewicht	2,5 - 10 kg
Glansspoelmiddel indicator	Indicator (lampje)	Min. en max plinthoogte	40 - 175 mm
Indicator einde cyclus	Op display, met akoestisch signaal	Verstelbare voetjes	8cm, from 820 to 900mm
Wassysteem	Standaard	Extra pakkingen	Ja
Derde sproeiarm	Enkel	Back cover	Ja
Waterontkalker	Elektronisch instelbaar	Diepte vaatwasser met open deur (mm)	1230
Aquatest sensor	Ja	Voetjes achterzijde vanaf de voorkant regelbaar	Ja
Overstroombeveiliging	Total Acquastop		

Performance / Energy Label - Reg. 2019

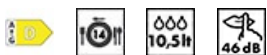







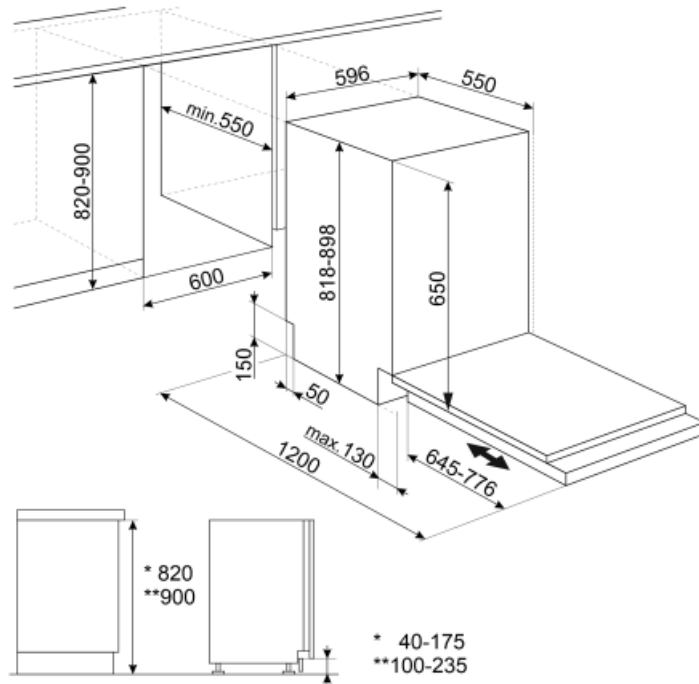













Energie-efficiëntieklasse (wascyclus)	D	Programmaduur	4:00 h:min
Energy consumption [per 100 cycles, based on the eco programme]	85 KWh	Geluidsniveau	46 dB(A) re 1 pW
Nominale capaciteit (ps)	14	Akoestisch geluidsemissieklasse	C
Water verbruik (per cyclus)	10,5 litres	Energy efficiency Index (EEI)	49,9

Elektrische aansluiting

Stekker	(F;E) Schuko	Frequentie	50 Hz
Aansluitwaarde	1800 W	Type aansluiting	Single-phase
Stroom	10 A	Lengte voedingskabel	140 cm



Symbols glossary (TT)

 <p>Aquatest meet de helderheid van het water tijdens een automatisch programma en zorgt automatisch voor een minimaal verbruik van water en energie</p>	 <p>82 cm high</p>
 <p>Vertragingstimer: De uitgestelde timer kan de start van het programma tot 24 uur uitstellen.</p>	 <p>Energy efficiency class D</p>
 <p>Option which improves the washing results of the selected programme. It increases the wash temperature and duration.</p>	 <p>The FlexiFit hinges allow the kitchen panel to slide over the dishwasher door, allowing a minimum kitchen plinth height of 5 cm.</p>
 <p>This option provides special care for a delicate load. It prevents rapid changes in the wash temperature of the selected programme and reduces it to 4</p>	 <p>The work aimed at continuous improvement has allowed the creation of the second generation of the Inverter motor 2.0, characterised by greater efficiency and durability over time, which allows very high performance and a lower energy consumption and noise level.</p>
 <p>Noise Level: Excellent insulation and special devices keep noise to a minimum.</p>	 <p>Wash cycle for normally soiled mixed loads such as dishes and pans, even with dried-on residues. When this program is selected, the dishwasher recognises the type of dirt and automatically adjusts the washing parameters as appropriate.</p>
 <p>Eco: Eco, this economic wash programme uses a low amount of water and energy in order to provide the most environmentally friendly cleaning option.</p>	 <p>A quick programme suitable for washing a load with fresh and light soil.</p>
 <p>Quick wash cycle for normally soiled mixed loads such as dishes and pans, even with dried-on residues. Dishes are washed and dried in 60 minutes.</p>	 <p>Programme suitable for washing and drying heavily soiled items with encrusted residues.</p>
 <p>Programme suitable for washing and drying normally soiled items.</p>	 <p>Dishwasher cleaning cycle. The cycle should be started with the machine empty, without dishes. It is recommended to run the program every 2-3 months, using special dishwasher detergents.</p>
 <p>Soak programme: The soak programme provides a rinse to prevent dirt from drying.</p>	 <p>14 place settings: Number of place settings.</p>
 <p>Total Acquastop: In addition to the partial Acquastop protection present in all Smeg dishwashers, some models have an electronic device fitted to the water intake hose, which monitors water levels in the machine, detects leaks in the hose and switches off the water supply immediately when necessary.</p>	 <p>System WaterSave ensures the best washing results with minimal water consumption depending on the model of dishwasher.</p>