

SO4401M1X

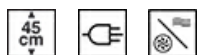

Categorie	45 cm
Familie	Oven
Voeding	Elektrisch
Warmte bron	Elektrisch
Bereidingswijze	Combi-magnetron
Technologie	Micro combi
EAN-code	8017709325732



Design

Esthetiek	Selezione	Kleur serigrafie	Zwart
Kleur	Roestvrij staal	Type zeefdruk	Symbolen
Afwerking	Vingervlekvrij	Deur	Met paneel
Design	Plat	Handgreep	Elementi/ Selezione
Materiaal	Roestvrij staal	Kleur handgreep	Squadrata
Type roestvrijstaal	Geborsteld	Logo	Roestvrijstaal
Type glas	Zwart	Bedieningsknoppen	In reliëf
			Elementi / Selezione

Bediening

			
Naam display	CompactScreen	Regeling bediening	Bedieningsknoppen
Display technologie	LCD	Aantal bedieningsknoppen	2

Programma's / functies

Aantal kookfuncties 10
Traditionele kookfuncties



Statisch



Geventileerd



Circolare

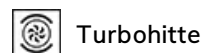

Turbohitte



ECO

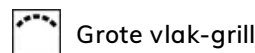

Grote vlak-grill

Bereidingsfuncties met microgolven



Magnetron



Geventileerd



Circulaire



Microwave + grill

Overige functies



Ontdooien op tijd

Opties



Opties tijdprogrammering	Automatische in- en uitschakeling
Timer	Ja
Timer	1
Kinderbeveiliging	Ja

Overige opties	Warmhoudfunctie
Showroom demo optie	Ja
Snelle voorverwarming	Ja

Technische specificaties



Minimum temperatuur	30 °C
Maximum temperatuur	250 °C
Aantal kookniveaus	2
Aantal lampen	1
Soort verlichting	Halogeen
Vermogen lamp	40 W
Automatische inschakeling verlichting bij openen deur	Ja
Grill - vermogen	1500 W
Automatische uitschakeling verhogingselementen bij openen deur	Ja
Deur openen	Standaard opening

Deur	Temperatuur gecontroleerde deur
Totaal aantal ruiten	3
Automatische uitschakeling magnetron bij openen deur	Ja
Chimney	Fixed
Koelsysteem	Mantelkoeling
Koelleiding	Enkel
Afmetingen bruikbare interne ovenruimte (hxbxd)	211x462x401 mm
Temperatuurregeling	Elektronisch
Materiaal ovenruimte	Ever Clean emaille
Veiligheidsscherm magnetrondeur	Ja

Prestaties / energielabel



Netto inhoud	40 l	Effectief magnetronvermogen	800 W
Aantal ovens	1		

Meegeleverde accessoires

Ovenrooster met stop	1	Glazen ovenplaat	1
-----------------------------	---	-------------------------	---

Inzetrooster

1

Elektrische aansluiting

Spanning 220-240 V
Stroom 14 A
Nominale aansluitwaarde 3100 W

Frequentie 50 Hz
Lengte voedingskabel 150 cm

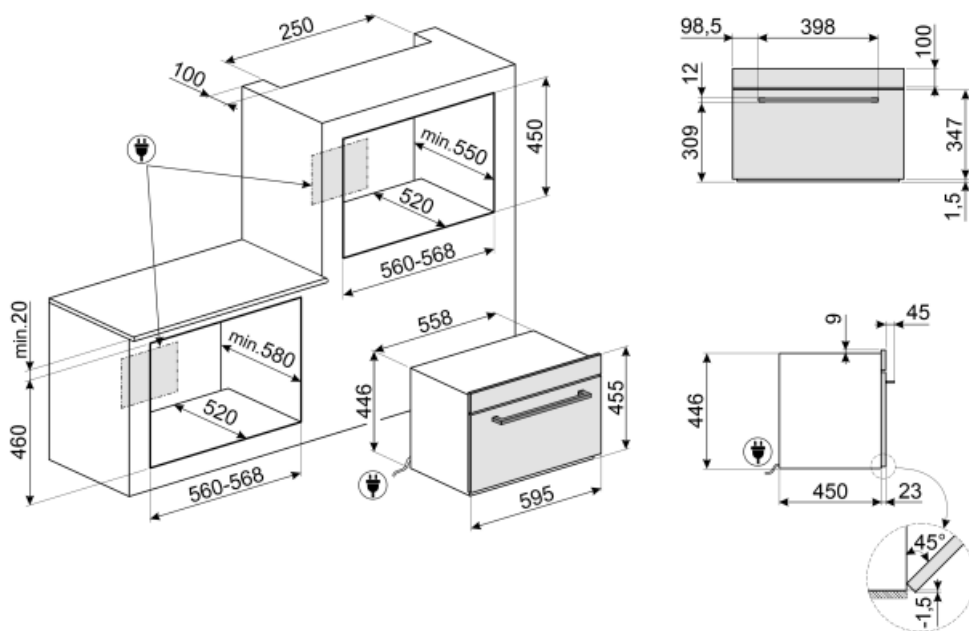

















Accessoires niet inbegrepen

AIRFRY

Airfryerrek AIRFRY . Ideaal voor traditioneel frituren in de oven, maar met minder calorieën en minder vet. Hiermee creëer je snel en eenvoudig gerechten zoals frites, gebakken groenten en vis, waardoor ze perfect bruin en krokant worden.



Symbols glossary (TT)

	Kinderslot: sommige modellen zijn voorzien van een apparaat om het programma / de cyclus te vergrendelen zodat het niet kan per ongeluk veranderd		Combination microwave: This oven allows to combine two different ways of cooking (Traditional with microwaves). Combined ovens increase cooking opportunities, while providing maximum flexibility of household appliances.
	Luchtkoelsysteem: om een veilig oppervlak te garanderen temperaturen.		Ontdooien op tijd: met deze functie wordt automatisch het tijdstip van ontdooien van voedsel bepaald
	With a simple and intuitive interface, the COMPACTscreen provides a pleasant user experience, thanks to the interaction with the knobs.		Deuren met driedubbele beglazing: aantal glazen deuren.
	Electric		Geëmailleerde binnenkant: De geëmailleerde binnenkant van alle Smeg-ovens heeft een speciale antacidumvoering die helpt om de binnenkant schoon te houden door de hoeveelheid kookvet te verminderen.
	Ventilator met bovenste en onderste elementen: de elementen in combinatie met de ventilator zijn bedoeld om een meer gelijkmatige warmte te bieden, een methode die vergelijkbaar is met conventioneel koken, dus voorverwarmen is vereist. Het meest geschikt voor items die langzaam koken vereisen.		De ovenruimte wordt tegelijk door het onder- en bovenelement verwarmt. De hitteverdeling over het gerecht is afhankelijk van het niveau waarop men dit plaatst. Geschikt voor bakken op 1 niveau. Gerechten: alle ovenschotels, vlees, gevogelte, brood, (gevulde) taarten. Speciaal: gans en eend (bevatten veel vet).
	Circulaire: it is the perfect function for cooking all types of dishes in a more delicate way. The heat comes from the back of the oven and is distributed quickly and evenly The fan is active. It is also ideal for cooking on multiple levels without mixing smells and flavors.		ECO: low energy consumption cooking: this function is particularly suitable for cooking on a single shelf with low energy consumption. It is recommended for all types of food except those that can generate a lot of moisture (for example vegetables). To achieve maximum energy savings and reduce time, it is recommended to put the food in the oven without preheating the cooking compartment
	De warmte wordt geproduceerd door het grill- en bovenelement. Verhitting over het volledige oppervlak. De thermostaat wordt, afhankelijk van het gerecht, in de regel op de maximale stand gezet. Bij een korte baktijd kan de oven deur gesloten blijven; bij langere baktijd blijft deze gedeeltelijk geopend. Voor vleesgerechten (klein- en middelgroot), vleespennen, vis, groenten, gratineren etc.		Microwave: Penetrating straight into the food, microwaves cook very quickly and with considerable energy savings. Suitable for cooking without fat, they are also able to thaw and heat food without altering its original appearance and aroma. The microwave function can also be combined with conventional functions with all the resulting advantages. Ideal for all types of food.
	Cooking with the simultaneous use of the heating element in combination with fan and microwave supply.		Microwave + grill element: The use of the grill results in a perfect browning of the surface of the food. The action of microwaves allows instead of cooking in a short time the internal part of the food.



Fan combined with traditional cooking, where heat is generated from above and below, provides uniform heat. Adding the microwave function allows the same cooking results in less time.



Compact appliances with a height of 45 cm - perfect solution to meet the functional requirements of kitchen sets of small height. Available in several types and in different styles.



verlichting



The oven cavity has 2 different cooking levels.



The capacity indicates the amount of usable space in the oven cavity in litres.



Turbo: the heat comes from 3 directions: above, below and from the back of the oven. The fan is active. It allows quick cooking, even on several shelves without mixing the aromas. Ideal for large volumes or foods that require intense cooking.



KEEP_WARM_72dpi



Rapid preheating: cooking is preceded by the preheating phase which allows the cooking compartment to reach the set temperature. This option reduces the time by up to 50%.



Electronic control: Allows you to maintain temperature inside the oven with the precision 2-3 ° C. This enables to cook meals that are very sensitive to temperature changes, such as cakes, souffles, puddings.