

SO4101M1B3

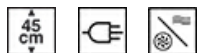

Categorie	45 cm
Familie	Oven
Voeding	Elektrisch
Warmte bron	Elektrisch
Bereidingswijze	Combi-magnetron
Technologie	Micro combi
EAN-code	8017709337292

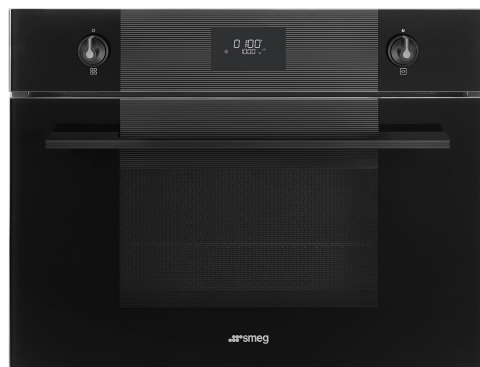

Design

Esthetiek	Linea	Type zeefdruk	Symbolen
Kleur	Zwart	Deur	Geheel glas
Afwerking	Glanzend	Handgreep	Linea minimal
Design	Plat	Kleur handgreep	Zwart
Materiaal	Glas	Logo	Geëtsd
Type glas	Clear1	Bedieningsknoppen	Linea
Kleur serigrafie	Grijs	Kleur knoppen	Zwart

Bediening

			
Naam display	CompactScreen	Regeling bediening	Bedieningsknoppen
Display technologie	LCD	Aantal bedieningsknoppen	2

Programma's / functies

Aantal kookfuncties 10

Traditionele kookfuncties



Statisch



Geventileerd



Circulaire

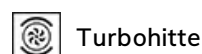

Turbohitte



ECO

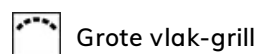

Grote vlak-grill

Bereidingsfuncties met microgolven

 Magnetron	 Geventileerd	 Circulaire
 Microwave + grill		

Overige functies

 Ontdooien op tijd
--

Opties



Opties	Automatische in- en uitschakeling	Overige opties	Warmhoudfunctie, ECO-Light
tijdprogrammering		Showroom demo optie	Ja
Timer	Ja	Snelle voorverwarming	Ja
Timer	1		
Kinderbeveiliging	Ja		

Technische specificaties



Minimum temperatuur	30 °C	Deur openen	Standaard opening
Maximum temperatuur	250 °C	Deur	Temperatuur gecontroleerde deur
Aantal kookniveaus	2	Totaal aantal ruiten	3
Aantal lampen	1	Automatische uitschakeling magnetron bij openen deur	Ja
Soort verlichting	Halogeen	Chimney	Fixed
Vermogen lamp	40 W	Koelsysteem	Mantelkoeling
Automatische inschakeling verlichting bij openen deur	Ja	Koelleiding	Enkel
Onderwarmte - vermogen	1000 W	Afmetingen bruikbare interne ovenruimte (hxbxd)	211x462x401 mm
Grill - vermogen	1750 W	Temperatuurregeling	Elektronisch
Circulatie - vermogen	1400 W	Materiaal ovenruimte	Ever Clean emaille
Automatische uitschakeling verhittingselementen bij openen deur	Ja	Veiligheidsscherm magnetrondeur	Ja

Prestaties / energielabel



Netto inhoud	40 l	Effectief magnetronvermogen	850 W
Aantal ovens	1		

Meegeleverde accessoires

Ovenrooster met stop 1
 Inzetrooster 1

Glazen ovenplaat 1







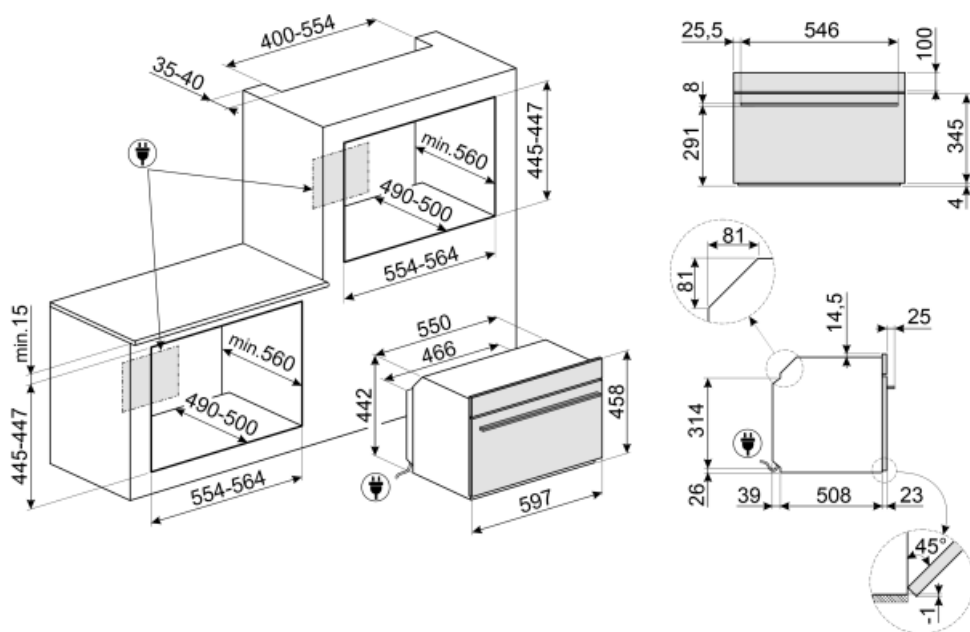









Elektrische aansluiting













Spanning 220-240 V
 Stroom 14 A
 Nominale aansluitwaarde 3100 W

Frequentie 50 Hz
 Lengte voedingskabel 150 cm



Symbols glossary (TT)

 <p>Kinderslot: sommige modellen zijn voorzien van een apparaat om het programma / de cyclus te vergrendelen zodat het niet kan per ongeluk veranderd</p>	 <p>Combination microwave: This oven allows to combine two different ways of cooking (Traditional with microwaves). Combined ovens increase cooking opportunities, while providing maximum flexibility of household appliances.</p>
 <p>Luchtkoelsysteem: om een veilig oppervlak te garanderen temperaturen.</p>	 <p>Ontdooien op tijd: met deze functie wordt automatisch het tijdstip van ontdooien van voedsel bepaald</p>
 <p>With a simple and intuitive interface, the COMPACTscreen provides a pleasant user experience, thanks to the interaction with the knobs.</p>	 <p>Deuren met driedubbele beglazing: aantal glazen deuren.</p>
 <p>Automatische verlichting gaat uit: voor meer energiebesparing schakelt de verlichting automatisch uit na één minuut na het begin van de bereiding.</p>	 <p>Electric</p>
 <p>Geëmailleerde binnenkant: De geëmailleerde binnenkant van alle Smeg-ovens heeft een speciale antacidumvoering die helpt om de binnenkant schoon te houden door de hoeveelheid kookvet te verminderen.</p>	 <p>Ventilator met bovenste en onderste elementen: de elementen in combinatie met de ventilator zijn bedoeld om een meer gelijkmatige warmte te bieden, een methode die vergelijkbaar is met conventioneel koken, dus voorverwarmen is vereist. Het meest geschikt voor items die langzaam koken vereisen.</p>
 <p>De ovenruimte wordt tegelijk door het onder- en bovenelement verwarmt. De hitteverdeling over het gerecht is afhankelijk van het niveau waarop men dit plaatst. Geschikt voor bakken op 1 niveau. Gerechten: alle ovenschotels, vlees, gevogelte, brood, (gevulde) taarten. Speciaal: gans en eend (bevatten veel vet).</p>	 <p>Circulaire: it is the perfect function for cooking all types of dishes in a more delicate way. The heat comes from the back of the oven and is distributed quickly and evenly The fan is active. It is also ideal for cooking on multiple levels without mixing smells and flavors.</p>
 <p>ECO: low energy consumption cooking: this function is particularly suitable for cooking on a single shelf with low energy consumption. It is recommended for all types of food except those that can generate a lot of moisture (for example vegetables). To achieve maximum energy savings and reduce time, it is recommended to put the food in the oven without preheating the cooking compartment</p>	 <p>De warmte wordt geproduceerd door het grill- en bovenelement. Verhitting over het volledige oppervlak. De thermostaat wordt, afhankelijk van het gerecht, in de regel op de maximale stand gezet. Bij een korte baktijd kan de oven deur gesloten blijven; bij langere baktijd blijft deze gedeeltelijk geopend. Voor vleesgerechten (klein- en middelgroot), vleespennen, vis, groenten, gratineren etc.</p>
 <p>Microwave: Penetrating straight into the food, microwaves cook very quickly and with considerable energy savings. Suitable for cooking without fat, they are also able to thaw and heat food without altering its original appearance and aroma. The microwave function can also be combined with conventional functions with all the resulting advantages. Ideal for all types of food.</p>	 <p>Cooking with the simultaneous use of the heating element in combination with fan and microwave supply.</p>

-
- | | |
|---|---|
|  <p>Microwave + grill element: The use of the grill results in a perfect browning of the surface of the food. The action of microwaves allows instead of cooking in a short time the internal part of the food.</p> |  <p>Fan combined with traditional cooking, where heat is generated from above and below, provides uniform heat. Adding the microwave function allows the same cooking results in less time.</p> |
|  <p>Turbo: the heat comes from 3 directions: above, below and from the back of the oven The fan is active. It allows quick cooking, even on several shelves without mixing the aromas. Ideal for large volumes or foods that require intense cooking.</p> |  <p>Compact appliances with a height of 45 cm - perfect solution to meet the functional requirements of kitchen sets of small height. Available in several types and in different styles.</p> |
|  <p>KEEP_WARM_72dpi</p> |  <p>Illuminated controls: are a safety device to alert the user that the appliance is on as well as being a stunning design feature.</p> |
|  <p>verlichting</p> |  <p>Rapid preheating: cooking is preceded by the preheating phase which allows the cooking compartment to reach the set temperature. This option reduces the time by up to 50%.</p> |
|  <p>The oven cavity has 2 different cooking levels.</p> |  <p>Electronic control: Allows you to maintain temperature inside the oven with the precision 2-3 ° C. This enables to cook meals that are very sensitive to temperature changes, such as cakes, souffles, puddings.</p> |
|  <p>Tilting grill: the tilting grill can be easily unhooked to move the heating element and clean the roof of the appliance in one simple step.</p> |  <p>The capacity indicates the amount of usable space in the oven cavity in litres.</p> |