

# CX91GMXNLK

Categorie fornuis	90x60 cm
Aantal ovens met energielabel	1
Cavity heat source	Elektrisch
Type kookplaat	Gas
Type primaire oven	Thermogeventileerd
Reinigingssysteem primaire oven	Vapor Clean
EAN-code	8017709349219
Energie-efficiëntieklasse	A



## Design



<b>Esthetiek</b>	Classici	<b>Type bediening</b>	Bedieningsknoppen
<b>Series</b>	Concerto	<b>Bedieningsknoppen</b>	Smeg Classici
<b>Design</b>	Standaard	<b>Kleur knoppen</b>	Roestvrij staal
<b>Kleur</b>	Roestvrij staal	<b>Aantal bedieningsknoppen</b>	8
<b>Afwerking</b>	Polished/Satin	<b>Kleur serigrafie</b>	Zwart
<b>Afwerking bedieningspaneel</b>	Gekleurd plaatstaal	<b>Deur</b>	Geheel glas
<b>Logo</b>	In reliëf	<b>Type glas</b>	Zwart
<b>Positie logo</b>	Strook onder de oven	<b>Handgreep</b>	Smeg Classici
<b>Kleur kookplaat</b>	Zwart glanzend	<b>Kleur handgreep</b>	Geborsteld roestvrijstaal
<b>Type pannendragers</b>	Mat zwart geëmailleerd	<b>Pootjes</b>	Zilver

## Programma's / functies

Aantal kookfuncties 6  
Traditionele kookfuncties



Statisch



Geventileerd



Turbo



ECO

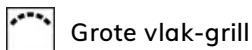

Grote vlak-grill

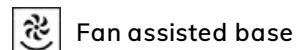

Fan assisted base

**Schoonmaak functie**



Vapor Clean

## Overige functies

 Ontdooien op tijd

## Opties kookplaat

Timer 1

## Technische specificaties kookplaat

UR

Totaal aantal kookzones 5

Linksvoor - Gas - RP - 2.90 kW

Linksachter - Gas - SRD - 1.80 kW

Midden - Gas - URP - 4.00 kW

Rechtsachter - Gas - SRD - 1.80 kW

Rechtsvoor - Gas - AUX - 1.00 kW

Type gasbranders Standaard

Automatische vonkontsteking Ja

Thermobeveiliging Ja

Branderdeksels

Mat zwart geëmailleerd

## Technische specificaties primaire oven

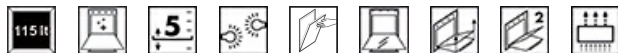

Aantal lampen 1

Aantal ventilatoren 1

Netto inhoud 115 l

Bruto inhoud 1e oven 129 l

Materiaal ovenruimte Ever Clean emaille

Aantal kookniveaus 5

Type ovenrekken Metalen zijsteunen

Soort verlichting Halogeen

Vermogen lamp 40 W

Instelling kooktijd Timer + einde bereiding

Deur openen naar beneden

Uitneembare ovendeur Ja

Volledig glazen binnendeur Ja

Uitneembaar glas binnendeur Ja

Aantal ruiten ovendeur 2

Aantal thermo-reflecterende ruiten 1

Veiligheidsthermostaat Ja

Koelsysteem Mantelkoeling

Afmetingen bruikbare interne ovenruimte (hxbxd) 371x724x418 mm

Temperatuurregeling Elektro-mechanisch

Onderwarmte - vermogen 1700 W

Bovenwarmte - vermogen 1200 W

Grill - vermogen 1700 W

Grote vlakgrill - vermogen 2900 W

Circulatie - vermogen 2000 W

Type grill Elektrisch

## Opties primaire oven

Maximum temperatuur 260 °C

Akoestisch signaal einde kooktijd	Ja
Minimum temperatuur	50 °C

## Meegeleverde accessoires primaire oven en kookplaat

Rek met achter- en zijstop	1	Bakplaat (20 mm)	1
-------------------------------	---	------------------	---

## Elektrische aansluiting

Stekker	(F;E) Schuko	Electric cable	Installed, Single phase
Aansluitwaarde	3200 W	Lengte voedingskabel	120 cm
Stroom	14 A	Frequentie	50/60 Hz
Spanning	220-240 V	Aansluitkast	3 polig

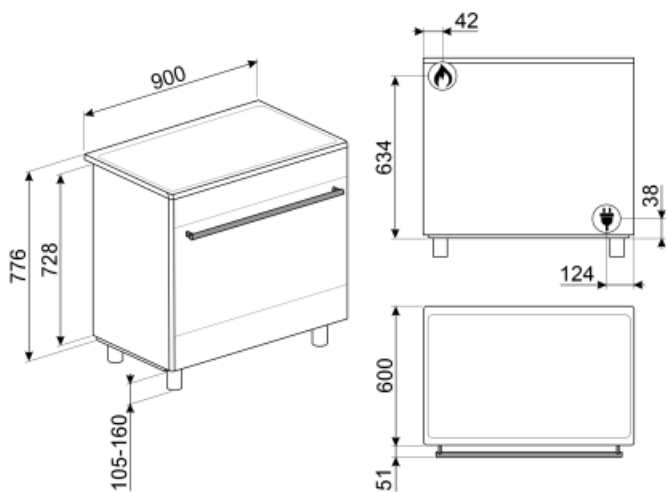

## Accessoires niet inbegrepen

### AIRFRY9

Air fryer rack AIRFRY . Ideal for recreating traditional frying in the oven, but with fewer calories and less fat. It allows you to cook quickly and simply dishes such as French fries, fried vegetables and fish, ensuring perfect browning and crispiness.



### GTP

Gedeeltelijk uittrekbare telescopische geleiders (1 niveau)



### PPR9

Refractory pizza stone without handles. Squared shaped stone: L64xH2,3xP37,5 cm Suitable also for gas ovens, to be put on the griddle.



### BG6090-1

Gietijzeren grillplaat geschikt voor Concerto fornuizen



### PPX6090-1

Stainless steel teppanyaki plate, suitable for Concerto cookers



### PALPZ

Pizzaschep met inklapbare handgreep breedte: 315 mm lengte: 325 mm



### SMOLD

Set van 7 siliconen vormpjes voor ijsjes, ijslolly's, pralines, ijsblokjes of om etenswaren te portioneren. Bruikbaar van -60 ° C tot + 230 ° C

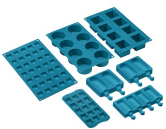

### SFLK1

Kinderslot



### PRTX

Ronde pizzasteen met handvaten, diameter 35 cm



### BBQ9



### KITH95

Hoogte uitbreidingsset (min.13cm - max.19,5cm), roestvrij staal



### KITPDQ

Height reduction feet (850mm), stainless steel, for Concerto cookers (850-881mm)





















### GTT

Volledig uittrekbare telescopische geleiders (1 niveau)



## Symbols glossary (TT)

 <p>A: Droogprestaties van het product, gemeten vanaf A +++ tot D / G afhankelijk van de productfamilie</p>	 <p>Installation in column: Installation in column</p>
 <p>Knobs control</p>	 <p>Luchtkoelsysteem: om een veilig oppervlak te garanderen temperaturen.</p>
 <p>Ontdooien op tijd: met deze functie wordt automatisch het tijdstip van ontdooien van voedsel bepaald</p>	 <p>Dubbele beglazing: aantal glazen deuren.</p>
 <p>Geëmailleerde binnenkant: De geëmailleerde binnenkant van alle Smeg-ovens heeft een speciale antacidumvoering die helpt om de binnenkant schoon te houden door de hoeveelheid kookvet te verminderen.</p>	 <p>Fan assisted base: the mix of fan and lower heating element alone allows to finish cooking foods already cooked on the surface but not internally more quickly. This system is recommended to finish cooking foods that are already well cooked on the surface, but not internally, which therefore require a moderate higher heat. Ideal for any type of food.</p>
 <p>Ventilator met bovenste en onderste elementen: de elementen in combinatie met de ventilator zijn bedoeld om een meer gelijkmatige warmte te bieden, een methode die vergelijkbaar is met conventioneel koken, dus voorverwarmen is vereist. Het meest geschikt voor items die langzaam koken vereisen.</p>	 <p>De ovenruimte wordt tegelijk door het onder- en bovenelement verwarmt. De hitteverdeling over het gerecht is afhankelijk van het niveau waarop men dit plaatst. Geschikt voor bakken op 1 niveau. Gerechten: alle ovenschotels, vlees, gevogelte, brood, (gevulde) taarten. Speciaal: gans en eend (bevatten veel vet).</p>
 <p>ECO: low energy consumption cooking: this function is particularly suitable for cooking on a single shelf with low energy consumption. It is recommended for all types of food except those that can generate a lot of moisture (for example vegetables). To achieve maximum energy savings and reduce time, it is recommended to put the food in the oven without preheating the cooking compartment</p>	 <p>De warmte wordt geproduceerd door het grill- en bovenelement. Verhitting over het volledige oppervlak. De thermostaat wordt, afhankelijk van het gerecht, in de regel op de maximale stand gezet. Bij een korte baktijd kan de oven deur gesloten blijven; bij langere baktijd blijft deze gedeeltelijk geopend. Voor vleesgerechten (klein- en middelgroot), vleespennen, vis, groenten, gratineren etc.</p>
 <p>Turbo: the heat comes from 3 directions: above, below and from the back of the oven The fan is active. It allows quick cooking, even on several shelves without mixing the aromas. Ideal for large volumes or foods that require intense cooking.</p>	 <p>Gas ovens offer instantaneous heat control, reduced cooking times and the ability to bake at much lower temperatures than electric ovens.</p>
 <p>All glass inner door: All glass inner door, a single flat surface which is simple to keep clean.</p>	 <p>The inner door glass: can be removed with a few quick movements for cleaning.</p>
 <p>verlichting</p>	 <p>Automatic opening: some models have Automatic opening door when the cycle is finished which is a perfect solution for handle-less kitchen units as no handle is needed. For safety reasons, the door locks automatically when the machine is in use to avoid it being opened inadvertently.</p>



The oven cavity has 5 different cooking levels.



Ultrasnelle branders: Krachtige ultrasnelle branders bieden tot 5kw vermogen.



Vapor Clean: a simple cleaning function using steam to loosen deposits in the oven cavity.



The capacity indicates the amount of usable space in the oven cavity in litres.

## Benefit (TT)

---

### **True-convection**

The best cooking performances guaranteed by ventilated circular flow

Multiple fans and heating elements guarantee the perfect aerodynamic heat flow, allowing homogeneous and quicker cooking inside the cavity.

### **Gas hob**

Gas provides permanent control of the heat source and the temperature change is immediate

Equipped with a thermocouple, the gas supply is cut off if the flame is extinguished for greater safety.

### **Vapor Clean**

By inserting water into a recess at the bottom of the cavity, steam is generated, which softens the residue and facilitates its removal

By inserting water into a recess at the bottom of the cavity, steam is generated, which softens the residue and facilitates its removal.

### **Single turbine**

The oven has a fan equipped with a circular heating element allowing cooking with rotating heat

### **Isothermic Cavity**

The best cooking performance at the highest energy efficiency

### **Tangential cooling**

New cooling system with tangential fan and airflow from the door to the splashback

### **Multilevel halogen light**

Internal halogen lighting on different levels guarantees excellent visibility

### **Adjustable height**

Cooker top flushed with the working area thanks to adjustable feet

### **Removable inner glass**

Internal door glasses are easily removable for complete cleaning

### **Multilevel cooking**

Several cooking levels allow maximum flexibility of use

### **Cold door**

During any function, the external door glass is cold, avoiding any risk of burns

---

**AirFry (AIRFRY optional accessory)**

Lighter and tastier food thanks to airfry basket (optional accessory)

**BBQ (optional accessory)**

Barbeque cooking directly in the oven with the double-sided grill (BBQ optional accessory)

**Pizza stone (optional accessory)**

Baking with refractory stone for soft and crispy pizza and yeast products (STONE optional accessory)