

# C6IMXM2

Categorie fornuis	60x60 cm
Aantal ovens met energielabel	1
Cavity heat source	Elektrisch
Type kookplaat	Inductie
Type primaire oven	Thermogeventileerd
Reinigingssysteem primaire oven	Vapor Clean
EAN-code	8017709330927
Energie-efficiëntieklasse	A



## Design



<b>Esthetiek</b>	Classici	<b>Aantal bedieningsknoppen</b>	6
<b>Series</b>	Sinfonia	<b>Kleur serigrafie</b>	Zwart
<b>Kleur</b>	RVS	<b>Type bediening</b>	Hybrid: Knobs + Touch
<b>Afwerking</b>	Geborsteld	<b>Slider</b>	Rood
<b>Design</b>	Squadrato	<b>Handgreep</b>	Smeg Classici
<b>Deur</b>	Met 2 horizontale stroken	<b>Kleur handgreep</b>	Geborsteld roestvrijstaal
<b>Kleur kookplaat</b>	RVS	<b>Type glas</b>	Eclipse zwart glas
<b>Afwerking bedieningspaneel</b>	Vingervlekvrij roestvrijstaal	<b>Pootjes</b>	Zilver
<b>Bedieningsknoppen</b>	Smeg Classici	<b>Opbergruimte</b>	Klep
<b>Kleur knoppen</b>	RVS	<b>Logo</b>	Assembled st/steel
<b>Display</b>	DigiScreen	<b>Positie logo</b>	Strook onder de oven

## Programma's / functies

Aantal kookfuncties 8

Traditionele kookfuncties



Statisch



Circulaire



Turbo



ECO



Kleine grill

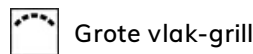

Grote vlak-grill

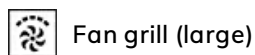

Fan grill (large)

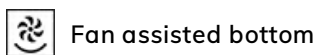

Fan assisted bottom

## Schoonmaak functie



## Opties kookplaat

ECO-Logic optie - stappen 1000, 1600, 2200, 2800, 3500, 6000, 7200 W

## Technische specificaties kookplaat



Totaal aantal kookzones 4

Linksvoor - Inductie - enkel - 1.60 kW - Booster 2.10 kW - Ø 21.0 cm

Linksachter - Inductie - enkel - 1.20 kW - Booster 1.60 kW - Ø 15.0 cm

Rechtsachter - Inductie - enkel - 1.60 kW - Booster 2.10 kW - Ø 21.0 cm

Rechtsvoor - Inductie - enkel - 1.20 kW - Booster 1.60 kW - Ø 15.0 cm

Automatische stop bij oververhitting Ja Indicator geselecteerde zone Ja

Automatische aanpassing panafmeting Ja Restwarmte indicator Ja

Indicator minimaal te gebruiken diameter Ja

## Technische specificaties primaire oven



Aantal lampen	1	Uitneembaar glas binnendeur	Ja
Aantal ventilatoren	1	Aantal ruiten ovendeur	3
Netto inhoud	70 l	Aantal thermo-reflecterende ruiten	2
Bruto inhoud 1e oven	79 l	Veiligheidsthermostaat	Ja
Materiaal ovenruimte	Ever Clean emaille	Koelsysteem	Mantelkoeling
Aantal kookniveaus	5	Afmetingen bruikbare interne ovenruimte (hxbxd)	360X460X425 mm
Type ovenrekken	Metalen zijsteunen	Temperatuurregeling	Elektro-mechanisch
Soort verlichting	Halogeen	Onderwarmte - vermogen	1200 W
Vermogen lamp	40 W	Bovenwarmte - vermogen	1000 W
Instelling kooktijd	Start en stop	Grill - vermogen	1700 W
Automatische inschakeling verlichting bij openen deur	Ja	Grote vlakgrill - vermogen	2700 W
Deur openen	naar beneden	Circulatie - vermogen	2000 W
Uitneembare ovendeur	Ja	Type grill	Elektrisch
Volledig glazen binnendeur	Ja		

## Opties primaire oven

Timer	Ja	Minimum temperatuur	50 °C
Akoestisch signaal einde kooktijd	Ja	Maximum temperatuur	260 °C

## Meegeleverde accessoires primaire oven en kookplaat

Rek met achter- en zijstop	1	Bakplaat (40 mm) Inzetrooster	1
Bakplaat (20 mm)	1		

## Elektrische aansluiting

Aansluitwaarde	10000 W	Type of electric cable installed	Yes, Single phase
Stroom	44 A	Type stroomkabel	Yes, Double and Three Phase
Spanning	220-240 V	Frequentie	50/60 Hz
Spanning 2 (V)	380-415 V	Aansluitkast	5 polig

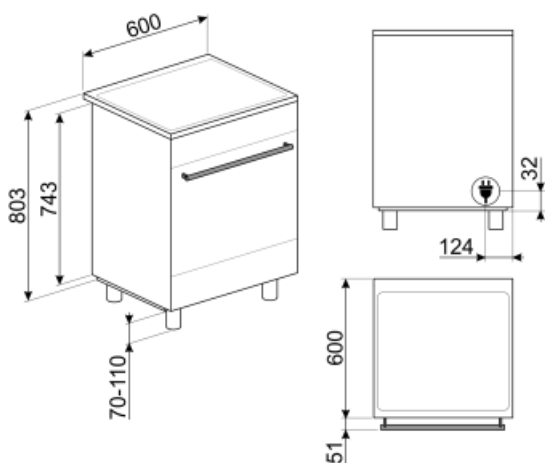

## Accessoires niet inbegrepen

### AIRFRY

Airfryerrek AIRFRY . Ideaal voor traditioneel frituren in de oven, maar met minder calorieën en minder vet. Hiermee creëer je snel en eenvoudig gerechten zoals frites, gebakken groenten en vis, waardoor ze perfect bruin en krokant worden.



### GTP

Gedeeltelijk uittrekbare telescopische geleiders (1 niveau)



### BNP608T

Teflon-coated tray, 8mm depth, to be placed on the grid



### KITPBX

Height reduction feet (850mm), st/steel, for Sinfonia and Master cookers (845-856mm)



### BN620-1

Geëmailleerde bakplaat, 20 mm diep



### BBQ

Dubbelzijdig



### TPKPLATE

Universal plate for induction, gas, ceramic and electric hobs. Non-stick surface ideal for cooking fish, eggs and vegetables. Dimensions: 410 X 240 mm.



### SFLK1

Kinderslot



### PRTX

Ronde pizzasteen met handvaten, diameter 35 cm



### GRILLPLATE

Universal griddle for induction, gas, ceramic and electric hobs. Non-stick surface ideal for cooking meat, cheese and vegetables. Dimensions: 410 x 240 mm.



### KITC6X

Splashback, 60cm, stainless steel, suitable for Master and Sinfonia cookers

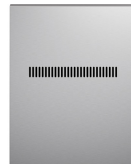

### SCRP

Inductie- en keramische kookplaten en teppanyaki-schraper



### STONE

Rectangular refractory stone Ideal for cooking pizzas with the same results as a typical wood-fired oven. Can also be used for baking bread, focaccias and other recipes such as pies, flans or biscuits Dimensions:L42 x H1,8 x P37,5 cm.



### PALPZ

Pizzaschep met inklapbare handgreep breedte: 315 mm lengte: 325 mm



### GTT

Volledig uittrekbare telescopische geleiders (1 niveau)



### SMOLD



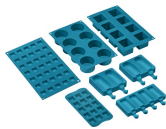









Set van 7 siliconen vormpjes voor ijsjes, ijslolly's, pralines, ijsblokjes of om etenswaren te portioneren. Bruikbaar van -60 ° C tot + 230 ° C













### BN640

Geëmailleerde bakplaat, 40 mm diep

## Symbols glossary (TT)

-  A: Droogprestaties van het product, gemeten vanaf A +++ tot D / G afhankelijk van de productfamilie
-  Deuren met driedubbele beglazing: aantal glazen deuren.
-  Vingerafdrukbestendig roestvrij staal: Vingerafdrukbestendig roestvrij staal zorgt ervoor dat roestvrij staal er zo goed als nieuw uitziet.
-  De ovenruimte wordt tegelijk door het onder- en bovenelement verwarmt. De hitteverdeling over het gerecht is afhankelijk van het niveau waarop men dit plaatst. Geschikt voor bakken op 1 niveau. Gerechten: alle ovenschotels, vlees, gevogelte, brood, (gevulde) taarten. Speciaal: gans en eend (bevatten veel vet).
-  ECO: low energy consumption cooking: this function is particularly suitable for cooking on a single shelf with low energy consumption. It is recommended for all types of food except those that can generate a lot of moisture (for example vegetables). To achieve maximum energy savings and reduce time, it is recommended to put the food in the oven without preheating the cooking compartment
-  De warmte is alleen afkomstig van het grill-element. Verhitting over een kleiner oppervlak. Te gebruiken als de grote vlak-grill, maar voor kleinere hoeveelheden
-  Luchtkoelsysteem: om een veilig oppervlak te garanderen temperaturen.
-  Geëmailleerde binnenkant: De geëmailleerde binnenkant van alle Smeg-ovens heeft een speciale antacidumvoering die helpt om de binnenkant schoon te houden door de hoeveelheid kookvet te verminderen.
-  Fan assisted base: the mix of fan and lower heating element alone allows to finish cooking foods already cooked on the surface but not internally more quickly. This system is recommended to finish cooking foods that are already well cooked on the surface, but not internally, which therefore require a moderate higher heat. Ideal for any type of food.
-  Circulaire: it is the perfect function for cooking all types of dishes in a more delicate way. The heat comes from the back of the oven and is distributed quickly and evenly The fan is active. It is also ideal for cooking on multiple levels without mixing smells and flavors.
-  De warmte wordt geproduceerd door het grill- en bovenelement. Verhitting over het volledige oppervlak. De thermostaat wordt, afhankelijk van het gerecht, in de regel op de maximale stand gezet. Bij een korte baktijd kan de oven deur gesloten blijven; bij langere baktijd blijft deze gedeeltelijk geopend. Voor vleesgerechten (klein- en middelgroot), vleespennen, vis, groenten, gratineren etc.
-  Ventilator met grillelement: De ventilator vermindert de felle hitte van de grill en biedt een uitstekende methode om verschillende soorten voedsel, karbonades, steaks, worstjes enz. Te grillen, waardoor het gelijkmatig bruin wordt en de warmte wordt verdeeld, zonder het voedsel uit te drogen. De bovenste twee niveaus die voor gebruik worden aanbevolen, en het onderste deel van de oven kunnen worden gebruikt om gerechten tegelijkertijd warm te houden, een uitstekende mogelijkheid bij het bereiden van een gegrild ontbijt. Halve grill (alleen middengedeelte) is ideaal voor kleine hoeveelheden voedsel.

- 
- |   |  |
|---|--|
|  <p>Turbo: the heat comes from 3 directions: above, below and from the back of the oven The fan is active. It allows quick cooking, even on several shelves without mixing the aromas. Ideal for large volumes or foods that require intense cooking.</p> |  <p>Overheat protection: The safety system that automatically turns off the hob in case of overheating of the control unit.</p> |
|  <p>Induction: The work of these hobs is based on the principle of electromagnetic induction. The heat is generated directly in the bottom of the pan during its contact with the hob.</p>  |  <p>All glass inner door: All glass inner door, a single flat surface which is simple to keep clean.</p>                        |
|  <p>The inner door glass: can be removed with a few quick movements for cleaning.</p>   |  <p>verlichting</p>   |
|  <p>Indication of residual heat: After the glass ceramic hob is switched off the residual heat indicator shows which of the heating zones still remains hot. When the temperature drops below 60 ° C, the indicator goes out.</p>                         |  <p>The oven cavity has 5 different cooking levels.</p>   |
|  <p>Vapor Clean: a simple cleaning function using steam to loosen deposits in the oven cavity.</p>  |  <p>The capacity indicates the amount of usable space in the oven cavity in litres.</p>   |
|  <p>4.3 inch display with LED technology, usability with knobs + 3 touch keys</p>  |  |

## Benefit (TT)

---

### **True-convection**

The best cooking performances guaranteed by ventilated circular flow

Multiple fans and heating elements guarantee the perfect aerodynamic heat flow, allowing homogeneous and quicker cooking inside the cavity.

### **Induction hob**

Induction offers fast cooking and precise temperature control

Through the use of suitable cookware, induction is easy to use and maintain, safe and responsive.

### **Vapor Clean**

By inserting water into a recess at the bottom of the cavity, steam is generated, which softens the residue and facilitates its removal

By inserting water into a recess at the bottom of the cavity, steam is generated, which softens the residue and facilitates its removal.

### **Touch control**

Easy and intuitive timer setting with a single touch

### **Single turbine**

The oven has a fan equipped with a circular heating element allowing cooking with rotating heat

### **Isothermic Cavity**

The best cooking performance at the highest energy efficiency

### **Tangential cooling**

New cooling system with tangential fan and airflow from the door to the splashback

### **Multilevel halogen light**

Internal halogen lighting on different levels guarantees excellent visibility

### **Adjustable height**

Cooker top flushed with the working area thanks to adjustable feet

### **Removable inner glass**

Internal door glasses are easily removable for complete cleaning

### **Multilevel cooking**

Several cooking levels allow maximum flexibility of use



### **Cold door**

During any function, the external door glass is cold, avoiding any risk of burns

### **AirFry (AIRFRY optional accessory)**

Lighter and tastier food thanks to airfry basket (optional accessory)

### **BBQ (optional accessory)**

Barbeque cooking directly in the oven with the double-sided grill (BBQ optional accessory)

### **Pizza stone (optional accessory)**

Baking with refractory stone for soft and crispy pizza and yeast products (STONE optional accessory)

### **Storage compartment**

More space thanks to the lower compartment, ideal for storing accessories or cooking utensils