

C6IMXT2

Categorie fornuis	60x60 cm
Aantal ovens met energielabel	1
Cavity heat source	Elektrisch
Type kookplaat	Inductie
Type primaire oven	Geventileerd
Reinigingssysteem primaire oven	Vapor Clean
EAN-code	8017709329013
Energie-efficiëntieklasse	A



Design









Esthetiek	Classici	Bedieningsknoppen	Smeg Classici
Series	Concerto	Kleur knoppen	Roestvrij staal
Design	Standaard	Aantal bedieningsknoppen	2
Kleur	Roestvrij staal	Kleur serigrafie	Zwart
Afwerking	Geborsteld	Display	DigiScreen
Afwerking bedieningspaneel	Roestvrij staal	Deur	Geheel glas
Logo	In reliëf	Type glas	Eclipse zwart glas
Positie logo	Strook onder de oven	Handgreep	Smeg Classici
Kleur kookplaat	Roestvrij staal	Kleur handgreep	Geborsteld roestvrijstaal
Type bediening	Touch control	Pootjes	Zwart
Slider	Rood		

Programma's / functies

Aantal kookfuncties 6

Traditionele kookfuncties

 Statisch	 Geventileerd	 ECO
 Grote vlak-grill	 Fan grill (large)	 Fan assisted base

Opties kookplaat



Kinderbeveiliging	Ja	ECO-Logic optie	Ja
Automatische uitschakeling	4	ECO-Logic optie - stappen	1000, 1600, 2200, 2800, 3500, 6000, 7200 W
Timer	1		

Technische specificaties kookplaat



Totaal aantal kookzones 4

Linksvoor - Inductie - enkel - 1.60 kW - Booster 2.10 kW - Ø 21.0 cm

Linksachter - Inductie - enkel - 1.20 kW - Booster 1.60 kW - Ø 15.0 cm

Rechtsachter - Inductie - enkel - 1.60 kW - Booster 2.10 kW - Ø 21.0 cm

Rechtsvoor - Inductie - enkel - 1.20 kW - Booster 1.60 kW - Ø 15.0 cm

Aantal kookzones met booster	4	Indicator minimaal te gebruiken diameter	Ja
Automatische stop bij oververhitting	Ja	Indicator geselecteerde zone	Ja
Automatische aanpassing panafmeting	Ja	Restwarmte indicator	Ja

Technische specificaties primaire oven



Aantal lampen	1	Uitneembaar glas binnendeur	Ja
Aantal ventilatoren	1	Aantal ruiten ovendeur	3
Netto inhoud	70 l	Aantal thermo-reflecterende ruiten	2
Bruto inhoud 1e oven	79 l	Veiligheidsthermostaat	Ja
Materiaal ovenruimte	Ever Clean emaille	Koelsysteem	Mantelkoeling
Aantal kookniveaus	5	Afmetingen bruikbare interne ovenruimte (hxbxd)	360X460X425 mm
Type ovenrekken	Metalen zijsteunen	Temperatuurregeling	Elektro-mechanisch
Soort verlichting	Halogeen	Onderwarmte - vermogen	1200 W
Vermogen lamp	40 W	Bovenwarmte - vermogen	1000 W
Instelling kooktijd	Eind	Grill - vermogen	1700 W
Deur openen	naar beneden	Grote vlakgrill - vermogen	2700 W
Uitneembare ovendeur	Ja	Type grill	Elektrisch
Volledig glazen binnendeur	Ja		

Opties primaire oven

Timer	Ja	Minimum temperatuur	50 °C
		Maximum temperatuur	260 °C

Akoestisch signaal einde kooktijd Ja

Meegeleverde accessoires primaire oven en kookplaat

Rek met achter- en zijstop 1 Bakplaat (40 mm) 1

Elektrische aansluiting

Aansluitwaarde	10000 W	Electric cable	Installed, Single phase
Stroom	44 A	Type stroomkabel	Double and Three Phase
Spanning	220-240 V	Frequentie	50/60 Hz
Spanning 2 (V)	380-415 V	Aansluitkast	5 polig

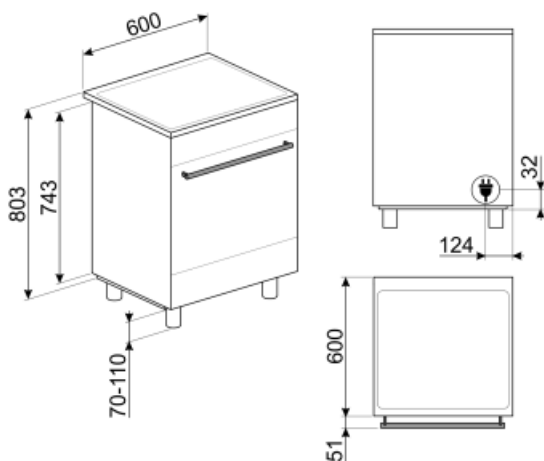

Accessoires niet inbegrepen



PPX6090

Stainless steel grill plate suitable for 90 cm Concerto cookers



SFLK1

Kinderslot

GTP

Gedeeltelijk uittrekbare telescopische geleiders (1 niveau)



PRTX

Ronde pizzasteen met handvaten, diameter 35 cm



BNP608T

Teflon-coated tray, 8mm depth, to be placed on the grid



KITH95

Hoogte uitbreidingsset (min.13cm - max.19,5cm), roestvrij staal



BN620-1

Geëmailleerde bakplaat, 20 mm diep



KITPDQ

Height reduction feet (850mm), stainless steel, for Concerto cookers (850-881mm)



SCRP

Inductie- en keramische kookplaten en teppanyaki-schraper



STONE

Rectangular refractory stone Ideal for cooking pizzas with the same results as a typical wood-fired oven. Can also be used for baking bread, focaccias and other recipes such as pies, flans or biscuits Dimensions:L42 x H1,8 x P37,5 cm.



PALPZ

Pizzaschep met inklapbare handgreep breedte: 315 mm lengte: 325 mm



KITP60X9

Splashback, stainless steel, suitable for 60X60cm Concerto cookers with pyro and MF oven



GTT

Volledig uittrekbare telescopische geleiders (1 niveau)



BN640

Geëmailleerde bakplaat, 40 mm diep







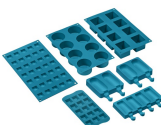





















SMOLD

Set van 7 siliconen vormpjes voor ijsjes, ijslolly's, pralines, ijsblokjes of om etenswaren te portioneren. Bruikbaar van -60 ° C tot + 230 ° C



Symbols glossary (TT)

 <p>Powerbooster: optie zorgt ervoor dat de zone op vol vermogen werkt wanneer zeer intensief koken nodig is.</p>	 <p>Kinderslot: sommige modellen zijn voorzien van een apparaat om het programma / de cyclus te vergrendelen zodat het niet kan per ongeluk veranderd</p>
 <p>A: Droogprestaties van het product, gemeten vanaf A +++ tot D / G afhankelijk van de productfamilie</p>	 <p>Installation in column: Installation in column</p>
 <p>Touch control</p>	 <p>Luchtkoelsysteem: om een veilig oppervlak te garanderen temperaturen.</p>
 <p>4.3 inch display with LED technology, usability with knobs + 3 touch keys</p>	 <p>Deuren met driedubbele beglazing: aantal glazen deuren.</p>
 <p>ECO-logic: optie stelt u in staat om de vermogenslimiet van de werkelijke energiebesparing van het apparaat te beperken</p>	 <p>Geëmailleerde binnenkant: De geëmailleerde binnenkant van alle Smeg-ovens heeft een speciale antacidumvoering die helpt om de binnenkant schoon te houden door de hoeveelheid kookvet te verminderen.</p>
 <p>Fan assisted base: the mix of fan and lower heating element alone allows to finish cooking foods already cooked on the surface but not internally more quickly. This system is recommended to finish cooking foods that are already well cooked on the surface, but not internally, which therefore require a moderate higher heat. Ideal for any type of food.</p>	 <p>Ventilator met bovenste en onderste elementen: de elementen in combinatie met de ventilator zijn bedoeld om een meer gelijkmatige warmte te bieden, een methode die vergelijkbaar is met conventioneel koken, dus voorverwarmen is vereist. Het meest geschikt voor items die langzaam koken vereisen.</p>
 <p>De ovenruimte wordt tegelijk door het onder- en bovinelement verwarmt. De hitteverdeling over het gerecht is afhankelijk van het niveau waarop men dit plaatst. Geschikt voor bakken op 1 niveau. Gerechten: alle ovenschotels, vlees, gevogelte, brood, (gevulde) taarten. Speciaal: gans en eend (bevatten veel vet).</p>	 <p>ECO: low energy consumption cooking: this function is particularly suitable for cooking on a single shelf with low energy consumption. It is recommended for all types of food except those that can generate a lot of moisture (for example vegetables). To achieve maximum energy savings and reduce time, it is recommended to put the food in the oven without preheating the cooking compartment</p>
 <p>De warmte wordt geproduceerd door het grill- en bovinelement. Verhitting over het volledige oppervlak. De thermostaat wordt, afhankelijk van het gerecht, in de regel op de maximale stand gezet. Bij een korte baktijd kan de ovendeur gesloten blijven; bij langere baktijd blijft deze gedeeltelijk geopend. Voor vleesgerechten (klein- en middelgroot), vleespennen, vis, groenten, gratineren etc.</p>	 <p>Ventilator met grillelement: De ventilator vermindert de felle hitte van de grill en biedt een uitstekende methode om verschillende soorten voedsel, karbonades, steaks, worstjes enz. Te grillen, waardoor het gelijkmatig bruin wordt en de warmte wordt verdeeld, zonder het voedsel uit te drogen. De bovenste twee niveaus die voor gebruik worden aanbevolen, en het onderste deel van de oven kunnen worden gebruikt om gerechten tegelijkertijd warm te houden, een uitstekende mogelijkheid bij het bereiden van een gegrild ontbijt. Halve grill (alleen middengedeelte) is ideaal voor kleine hoeveelheden voedsel.</p>

-
-  Overheat protection: The safety system that automatically turns off the hob in case of overheating of the control unit.
-  All glass inner door: All glass inner door, a single flat surface which is simple to keep clean.
-  verlichting
-  Indication of residual heat: After the glass ceramic hob is switched off the residual heat indicator shows which of the heating zones still remains hot. When the temperature drops below 60 ° C, the indicator goes out.
-  Timer: All ceramic hobs have a timer which automatically ends cooking after a preset time.
-  The capacity indicates the amount of usable space in the oven cavity in litres.
-  Induction: The work of these hobs is based on the principle of electromagnetic induction. The heat is generated directly in the bottom of the pan during its contact with the hob.
-  The inner door glass: can be removed with a few quick movements for cleaning.
-  Automatic opening: some models have Automatic opening door when the cycle is finished which is a perfect solution for handle-less kitchen units as no handle is needed. For safety reasons, the door locks automatically when the machine is in use to avoid it being opened inadvertently.
-  The oven cavity has 5 different cooking levels.
-  Vapor Clean: a simple cleaning function using steam to loosen deposits in the oven cavity.

Benefit (TT)

Induction hob

Induction offers fast cooking and precise temperature control

Through the use of suitable cookware, induction is easy to use and maintain, safe and responsive.

Vapor Clean

By inserting water into a recess at the bottom of the cavity, steam is generated, which softens the residue and facilitates its removal

By inserting water into a recess at the bottom of the cavity, steam is generated, which softens the residue and facilitates its removal.

Touch control

Easy and intuitive timer setting with a single touch

Single turbine

The oven has a fan equipped with a circular heating element allowing cooking with rotating heat

Isothermic Cavity

The best cooking performance at the highest energy efficiency

Tangential cooling

New cooling system with tangential fan and airflow from the door to the splashback

Multilevel halogen light

Internal halogen lighting on different levels guarantees excellent visibility

Adjustable height

Cooker top flushed with the working area thanks to adjustable feet

Removable inner glass

Internal door glasses are easily removable for complete cleaning

Multilevel cooking

Several cooking levels allow maximum flexibility of use

Cold door

During any function, the external door glass is cold, avoiding any risk of burns

AirFry (AIRFRY optional accessory)

Lighter and tastier food thanks to airfry basket (optional accessory)

BBQ (optional accessory)

Barbeque cooking directly in the oven with the double-sided grill (BBQ optional accessory)

Pizza stone (optional accessory)

Baking with refractory stone for soft and crispy pizza and yeast products (STONE optional accessory)