

# **NOVY**

## **Novy Wall**

740101 – 740102 – 740201 – 740202 –  
740301 – 740302 – 740401 – 740402 –  
740501 – 740502 – 740601 – 740602 –  
740701 – 740702 – 740801 – 740802

# INHOUD

---

<b>1</b>	<b>ALGEMEEN</b>	<b>3</b>
<b>2</b>	<b>INSTALLATIE VOORSCHRIFTEN</b>	<b>4</b>
<b>3</b>	<b>BENODIGDHEDEN</b>	<b>5</b>
<b>4</b>	<b>MONTAGE INSTRUCTIES</b>	<b>6</b>

# 1 ALGEMEEN

Dit is de montage-instructie voor het op de voorzijde aangegeven Novy-toestel. Lees aandachtig de veiligheidsvoorschriften, de montagehandleiding en de gebruiksaanwijzing vóór de installatie en in gebruikname.

De veiligheidsvoorschriften staan vermeld in een apart boekje dat met het toestel is meegeleverd en wordt ook op onze website [www.novy.com](http://www.novy.com) vermeld.

Leef de veiligheidsvoorschriften, de montagehandleiding en de gebruiksaanwijzing na om letsel en materiële schade te voorkomen.

In deze montage-instructie wordt gewerkt met een aantal symbolen. Hieronder vind u de betekenis van deze symbolen.

<b>Symbool</b>	<b>Betekenis</b>	<b>Actie</b>
	Lezen	Lees de instructie goed.
	Waarschuwing	Dit symbool duidt op een gevaarlijke situatie.

## 2 INSTALLATIE VOORSCHRIFTEN

 Dit product bevat een sfeerlicht verlichtingsbron van energie-efficiëntieklasse F.

 Dit product bevat een functioneel licht verlichtingsbron van energie-efficiëntieklasse E.

 Het product mag enkel geïnstalleerd worden door een gekwalificeerde en getrainde installateur.

 Verlichtingsbron (enkel LED) kan enkel vervangen worden door een erkend installateur.

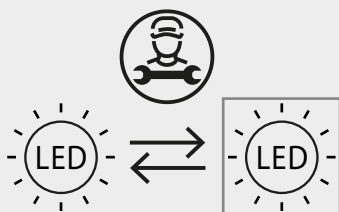

 Verlichtingsadaptor kan enkel vervangen worden door een erkend installateur.

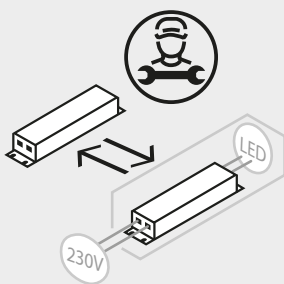

 Schakel tijdens de installatie de stroom uit op de voorziene stroomkabel.

 Voorzie een aan-uitschakelaar bij de stroomtoevoer van de netspanning.

### 3 BENODIGDHEDEN



Controleer of de benodigde accessoires zijn meegeleverd.

1

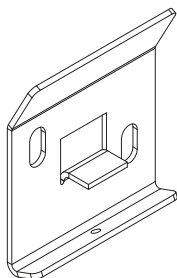

zwart: 2x 7000017806  
wit: 2x 7000017807



zwart: 2x 70000191  
wit: 2x 70000183

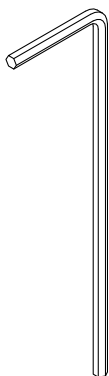

1x 53005145

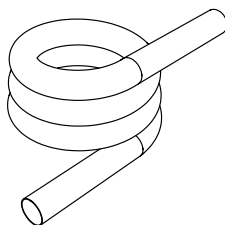

1x 70000206

## 4 MONTAGE INSTRUCTIES

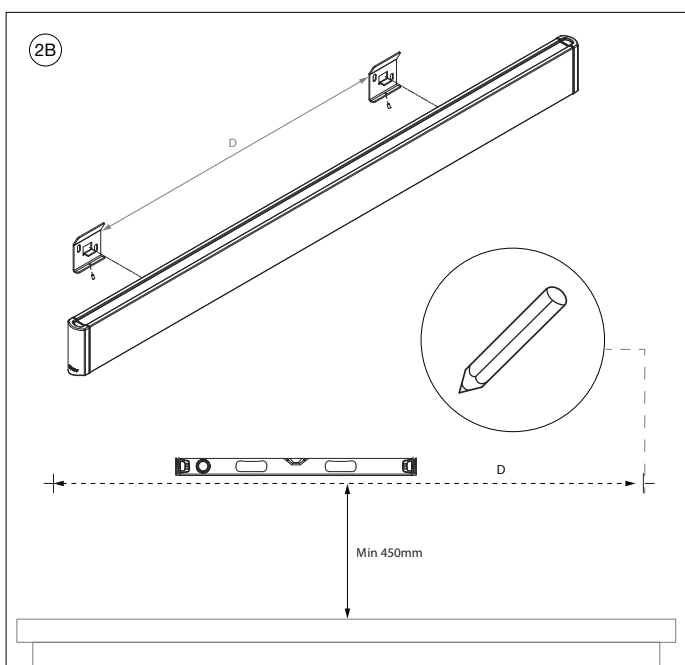
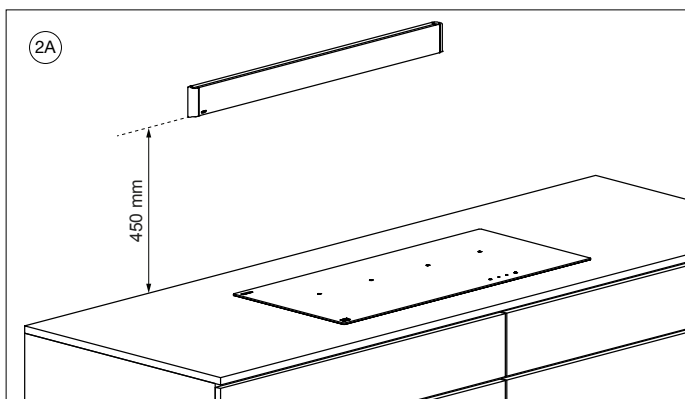

**OPGELET:** De elektrische aansluiting uit de muur kan niet voorzien worden langs de eerste 550 mm aan de rechterkant van het armatuur.

2A Bepaal de gewenste positie van de Novy Wall. Zorg ervoor dat er minimaal 45 cm afstand is tussen de onderkant van het armatuur en het werkblad om de veiligheid en functionaliteit te waarborgen.

2B Teken de plek van de installatiebeugeltjes af op de muur. De maximale afstand (D) tussen de beugels (centerpunt tot centerpunt) wordt weergegeven in de tabel.

Product	D max (mm)	Product	D max (mm)
Novy Wall 95	735	Novy Wall 215	1895
Novy Wall 125	1025	Novy Wall 245	2185
Novy Wall 155	1315	Novy Wall 275	2475
Novy Wall 185	1605	Novy Wall 305	2765

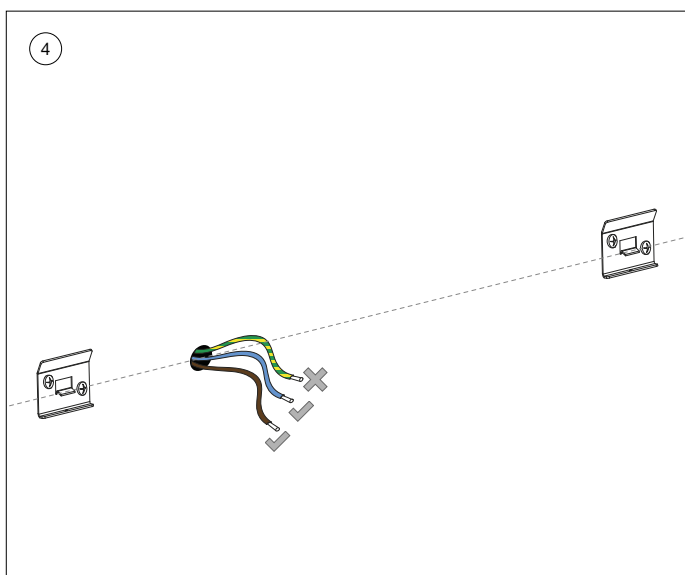
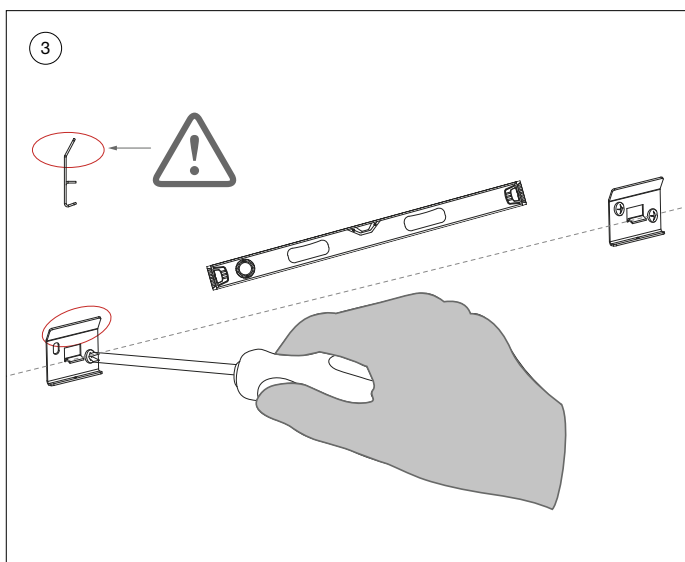

- 3 Bevestig de beugels, met de correcte zijde bovenaan (zie afbeelding), aan de muur. Let erop dat de bovenkant van beide beugels waterpas is.



**OPGELET: Gebruik geschikt bevestigingsmateriaal voor het type muur waarop het armatuur geïnstalleerd wordt.**

- 4 Voorzie de elektrische aansluitkabel uit de muur. Enkel lijn- en neutrale kabel is nodig, scherm de aarding af.

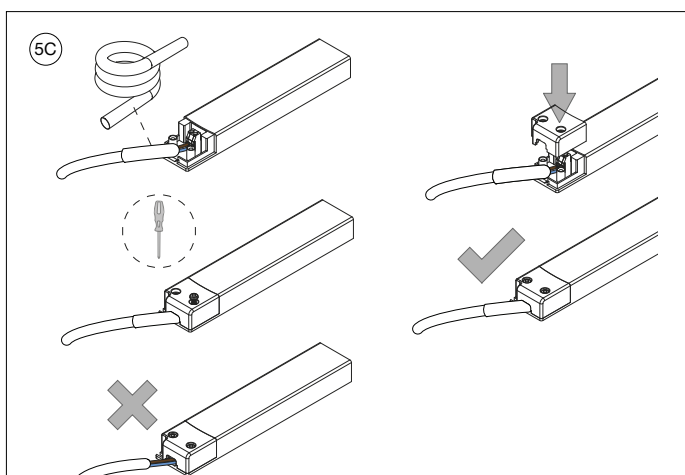
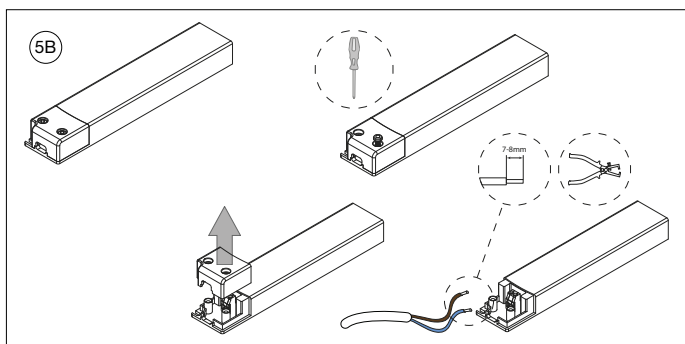
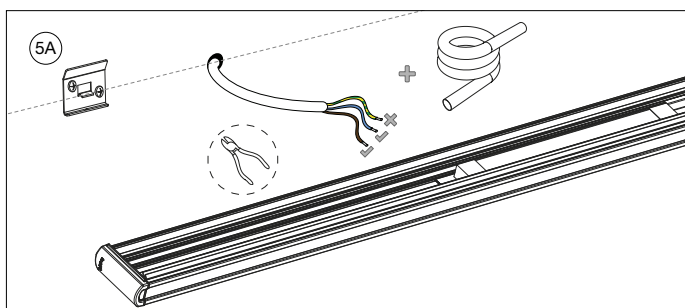

- 5A) Bereid de elektrische kabel voor.  
Gebruik de meegeleverde isolatieslang om de kabel te beschermen.  
Scherm de aarding af.
- 5B) Verwijder het oranje kapje van de driver in het armatuur. Strip de lijn- en neutrale kabel.
- 5C) Gebruik de meegeleverde isolatieslang om de kabels tot onder het oranje kapje af te screenen. Sluit de elektrische kabels volgens de markeringen op de driver aan. Plaats het oranje kapje terug op de driver.



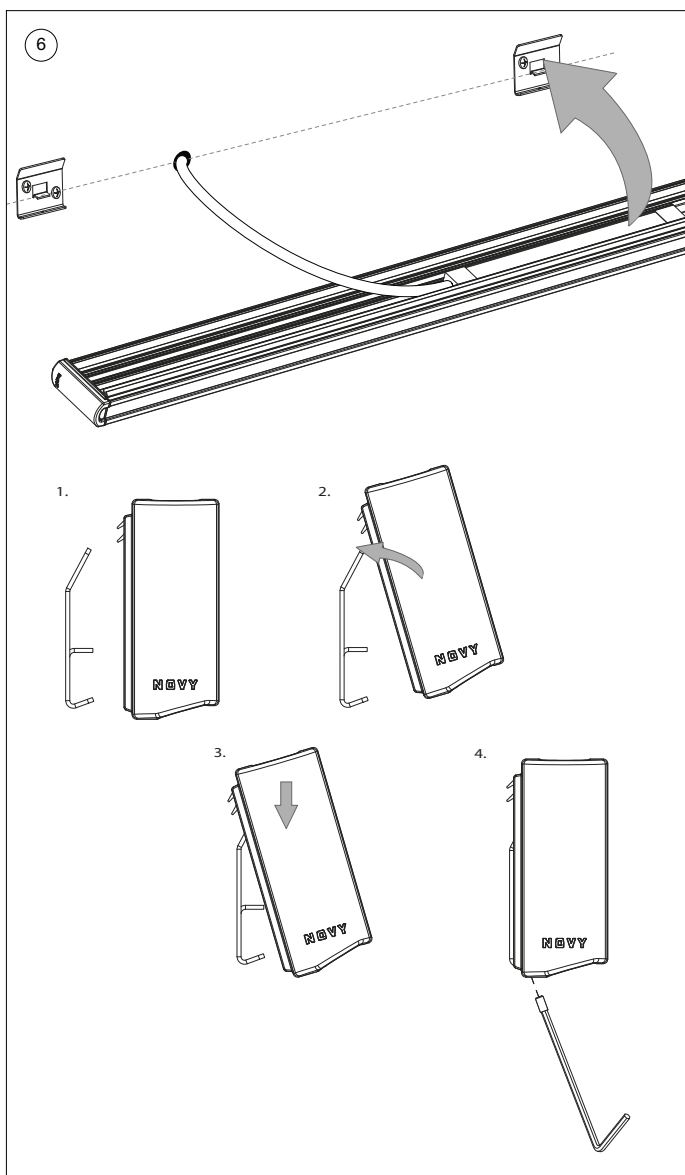

- 6 Laat het armatuur op de beugels rusten. Bevestig daarna het armatuur op de beugels door middel van de inbusschroefjes onderaan de beugeltjes. Schakel de stroom in en het apparaat is klaar voor gebruik.



**OPGELET: Verberg eventueel overtollige kabel in het armatuur.**

## **CONTENU**

---

<b>1</b>	<b>INFORMATIONS GÉNÉRALES</b>	<b>11</b>
<b>2</b>	<b>CONSIGNES D'INSTALLATION</b>	<b>12</b>
<b>3</b>	<b>FOURNITURES</b>	<b>13</b>
<b>4</b>	<b>INSTRUCTIONS D'INSTALLATION</b>	<b>14</b>



# 1 INFORMATIONS GÉNÉRALES

Il s'agit de les instructions d'installation de l'appareil Novy illustré en page de couverture. Lisez attentivement les consignes de sécurité, les instructions de montage et le mode d'emploi avant l'installation et la mise en service de l'appareil.

Les consignes de sécurité sont énumérées dans un livret séparé fourni avec l'appareil et indiqué sur notre site web [www.novy.com](http://www.novy.com).

Respectez les consignes de sécurité, les instructions de montage et le mode d'emploi afin d'éviter les blessures et les dommages matériels.

Cettes instructions d'installation utilisent plusieurs symboles. Vous en trouverez la signification ci-dessous.

<b>Symbole</b>	<b>Signification</b>	<b>Action</b>
	Indication	Explication d'une indication apparaissant sur l'appareil.
	Information/ Avertissement	Ce symbole signale un conseil important ou une situation dangereuse.

## 2 CONSIGNES D'INSTALLATION

 Ce produit contient une source lumineuse à lumière d'ambiance de classe d'efficacité énergétique F.

 Ce produit contient une source lumineuse à lumière fonctionnelle de classe d'efficacité énergétique E.

 Le produit ne doit être installé que par un installateur formé et agréé.

 La source d'éclairage (LED uniquement) ne peut être remplacée que par un installateur agréé.

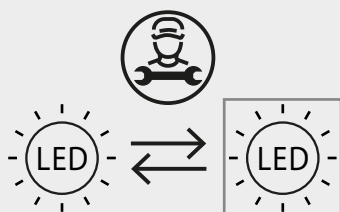

 Le ballast ne peut être remplacé que par un installateur agréé.

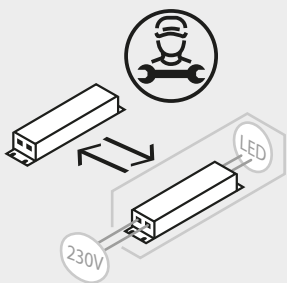

 Coupez l'alimentation du câble d'alimentation désigné pendant l'installation.

 Prévoyez un interrupteur marche-arrêt au niveau de l'alimentation électrique.

### 3 FOURNITURES



**Vérifiez si les accessoires nécessaires sont inclus.**

1

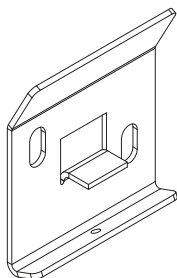

noir: 2x 7000017806  
blanc: 2x 7000017807



noir: 2x 70000191  
blanc: 2x 70000183

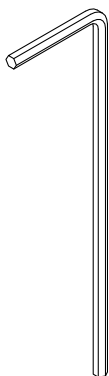

1x 53005145

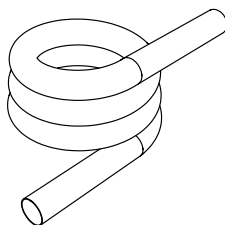

1x 70000206

## 4 INSTRUCTIONS D'INSTALLATION

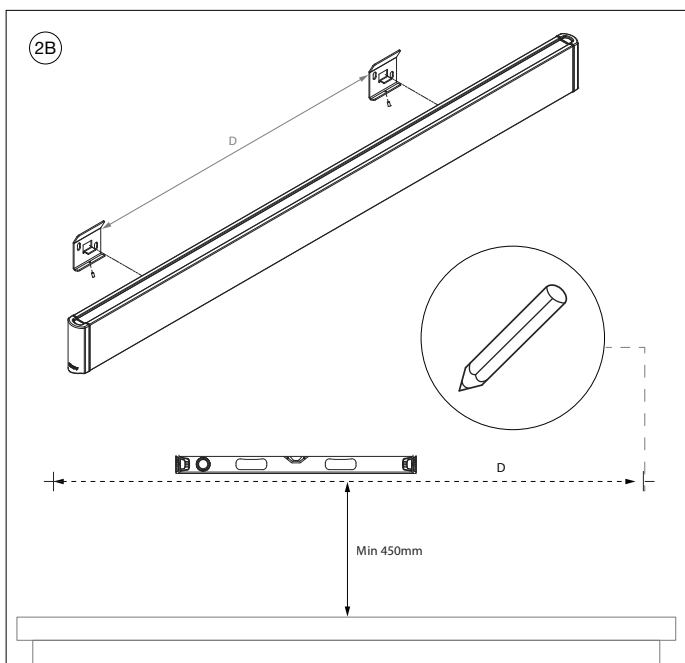
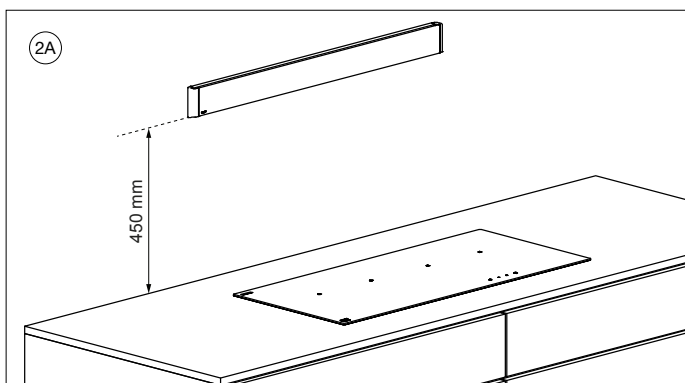

**ATTENTION : le raccordement électrique du mur ne peut pas se faire dans les 550 premiers millimètres sur la droite du luminaire.**

- 2A Déterminez la position souhaitée du Novy Wall. Veillez à garder une distance d'au moins 45 cm entre le bas du luminaire et le plan de travail afin de garantir la sécurité et la fonctionnalité.
- 2B Marquez l'emplacement des supports d'installation sur le mur. La distance maximale entre les supports (d'un point central à l'autre) est indiquée dans le tableau.

produit	D max (mm)	produit	D max (mm)
Novy Wall 95	735	Novy Wall 215	1895
Novy Wall 125	1025	Novy Wall 245	2185
Novy Wall 155	1315	Novy Wall 275	2475
Novy Wall 185	1605	Novy Wall 305	2765

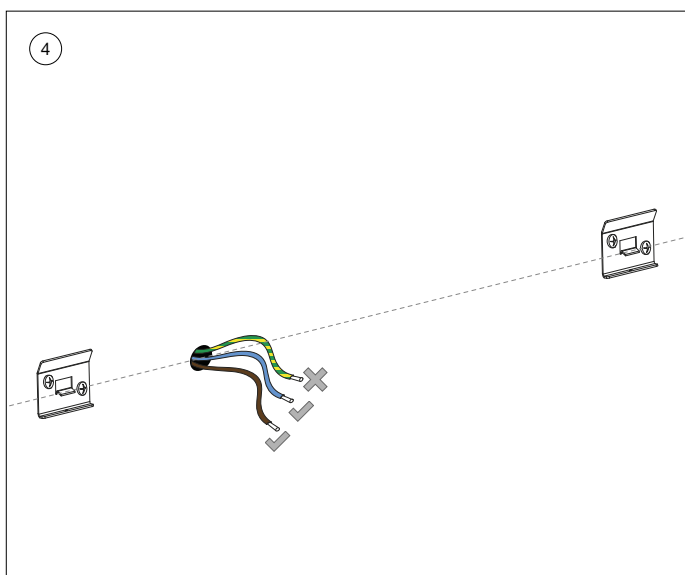
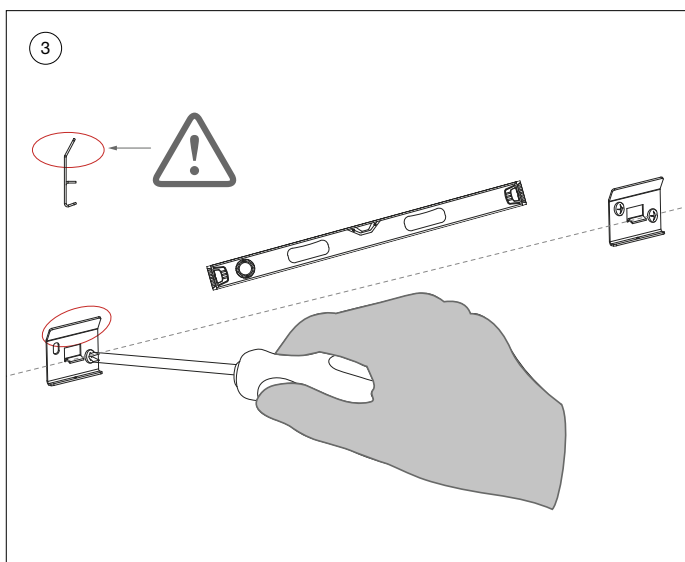

- 3 Fixez les supports au mur, avec le bon côté vers le haut (voir schéma). Veillez à ce que le dessus des deux supports soit de niveau.



**ATTENTION : utilisez le matériel de montage approprié au type de mur où sera installé le luminaire.**

- 4 Prévoyez le câble de raccordement électrique depuis le mur. Seuls les câbles de ligne et neutre sont nécessaires ; gainez le câble de terre.

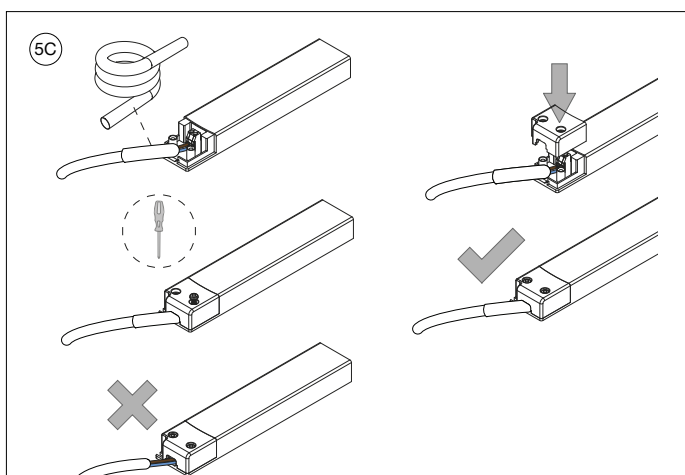
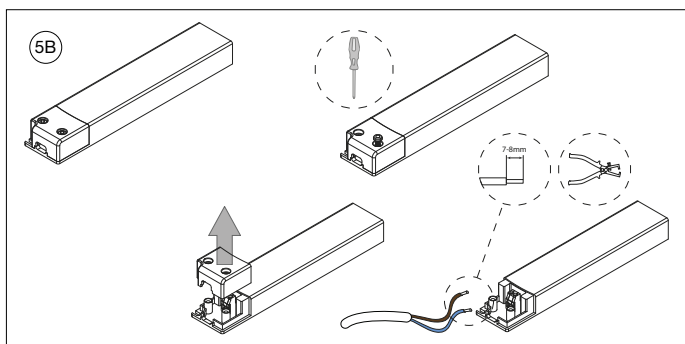
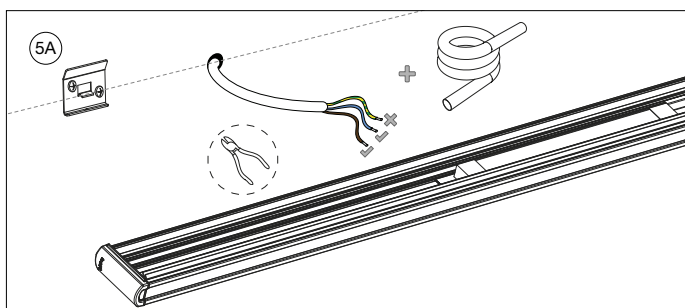

- 5A) Préparez le câble électrique. Utilisez le manchon d'isolation fourni pour protéger le câble. Gainez le câble de terre.
- 5B) Retirez le capuchon orange du ballast dans le luminaire. Dénudez les câbles de ligne et neutre.
- 5C) Utilisez le manchon d'isolation fourni pour protéger les câbles jusqu'en dessous du capuchon orange. Raccordez les câbles électriques d'après les marquages sur le ballast. Remplacez le capuchon orange sur le ballast.



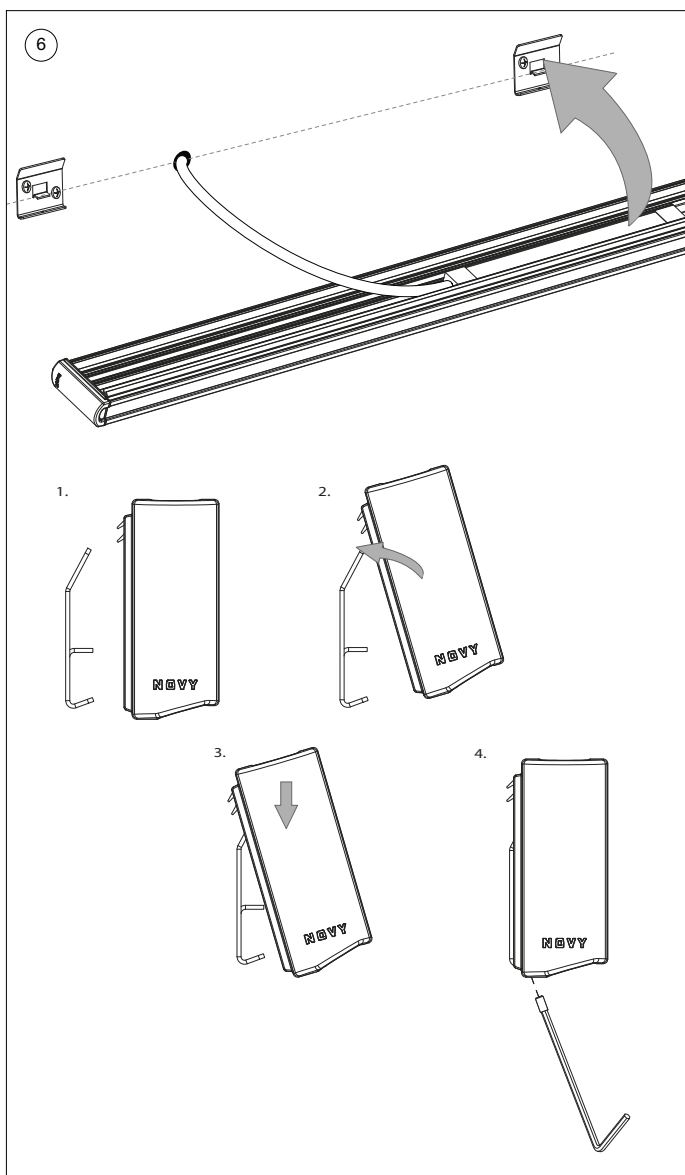

- 6 Posez le luminaire sur les supports. Ensuite, fixez le luminaire aux supports à l'aide des vis Allen en bas des supports. Allumez le courant et le luminaire est prêt à l'emploi.



**ATTENTION : dissimulez l'excédent de câble à l'intérieur du luminaire.**

## INHALT

---

<b>1</b>	<b>ALLGEMEINE INFORMATIONEN</b>	<b>19</b>
<b>2</b>	<b>MONTAGEVORSCHRIFTEN</b>	<b>20</b>
<b>3</b>	<b>ZUBEHÖR</b>	<b>21</b>
<b>4</b>	<b>MONTAGEANLEITUNG</b>	<b>22</b>



# 1 ALLGEMEINE INFORMATIONEN

Dies ist die Montageanleitung für das auf der Vorderseite genannte Novy Gerät. Lesen Sie die Sicherheitshinweise, die Montageanleitung und die Bedienungsanleitung vor der Installation und der Inbetriebnahme sorgfältig durch.

Die Sicherheitshinweise finden Sie in einer separaten Broschüre, die zum Lieferumfang Ihres Novy Gerätes gehört. Sie können die Sicherheitshinweise auch auf unserer Website [www.novy.com](http://www.novy.com) finden.

Beachten Sie die Sicherheitshinweise, die Montageanleitung und die Bedienungsanleitung, um Verletzungen und Beschädigung des Gerätes zu vermeiden.

Die Anleitung enthält einige Symbole, deren Bedeutung im Folgenden erläutert wird.

Symbol	Bedeutung	Aktion
	Anzeige	Erläuterung einer Anzeige auf dem Gerät.
	Info/ Warnhinweis	Dieses Symbol weist auf einen wichtigen Tipp oder eine gefährliche Situation hin.

## 2 MONTAGEVORSCHRIFTEN

 Dieses Produkt enthält eine Stimmungslichtquelle der Energieeffizienzklasse F.

 Dieses Produkt enthält eine funktionelle Lichtquelle der Energieeffizienzklasse E.

 Das Produkt darf nur durch einen qualifizierten, entsprechend geschulten Monteur installiert werden.

 Leuchtmittel (nur LED) können nur von einem anerkannten Monteur ausgetauscht werden.

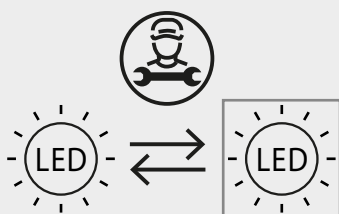

 Das Vorschaltgerät kann nur von einem anerkannten Monteur ausgetauscht werden.

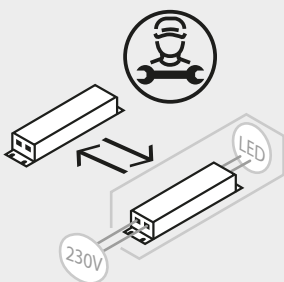

 Schalten Sie die Stromversorgung des vorgesehenen Netzkabels während der Montage aus.

 Sehen Sie einen Ein-Aus-Schalter an der Netzstromversorgung vor.

### 3 ZUBEHÖR



Prüfen Sie, ob alle erforderlichen  
Zubehörteile vorhanden sind.

1

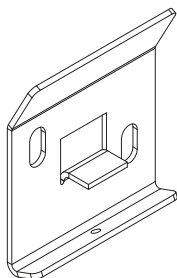

schwarz: 2x 7000017806  
weiß: 2x 7000017807



schwarz: 2x 70000191  
weiß: 2x 70000183

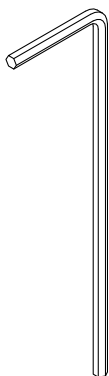

1x 53005145

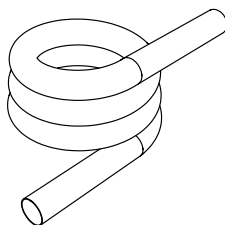

1x 70000206

## 4 MONTAGEANLEITUNG

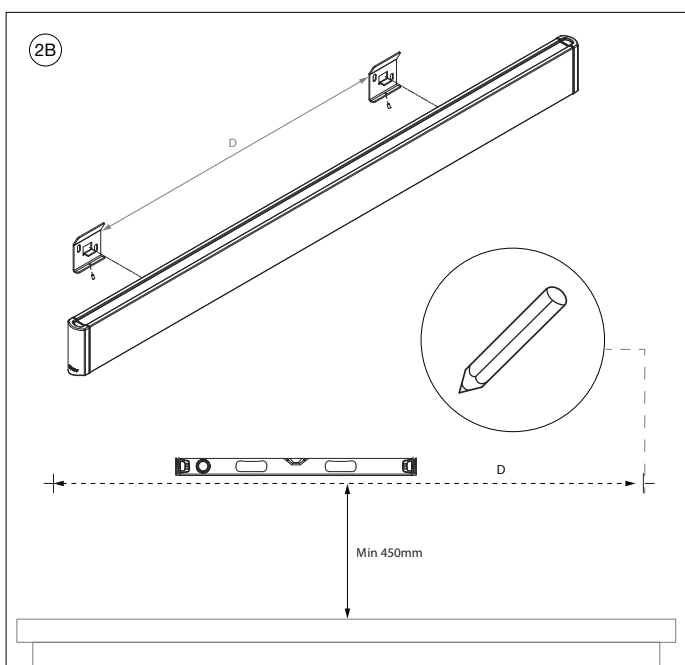
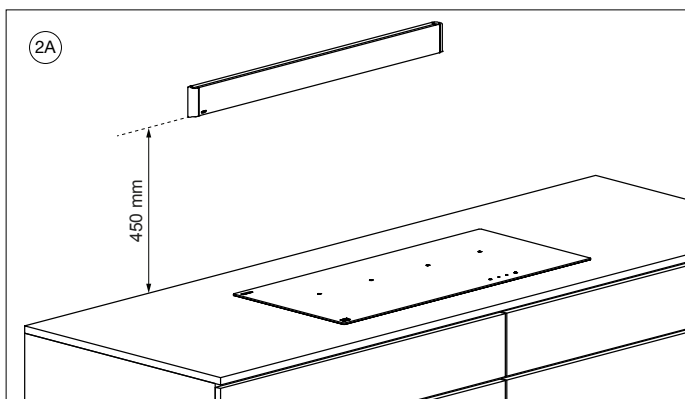

**ACHTUNG:** Der elektrische Anschluss in der Wand kann nicht innerhalb der ersten 550 mm auf der rechten Seite der Befestigung hergestellt werden.

2A Bestimmen Sie die gewünschte Position der Novy Wall. Sorgen Sie für einen minimalen Abstand von 45 cm zwischen Befestigung und Arbeitsplatte, um Sicherheit und Funktionalität zu gewährleisten.

2B Markieren Sie, wo die Montagehalterungen an der Wand angebracht werden sollen. Der maximale Abstand zwischen den Halterungen (Mittelpunkt zu Mittelpunkt) ist in der Tabelle angegeben.

Produkt	D max (mm)	Produkt	D max (mm)
Novy Wall 95	735	Novy Wall 215	1895
Novy Wall 125	1025	Novy Wall 245	2185
Novy Wall 155	1315	Novy Wall 275	2475
Novy Wall 185	1605	Novy Wall 305	2765

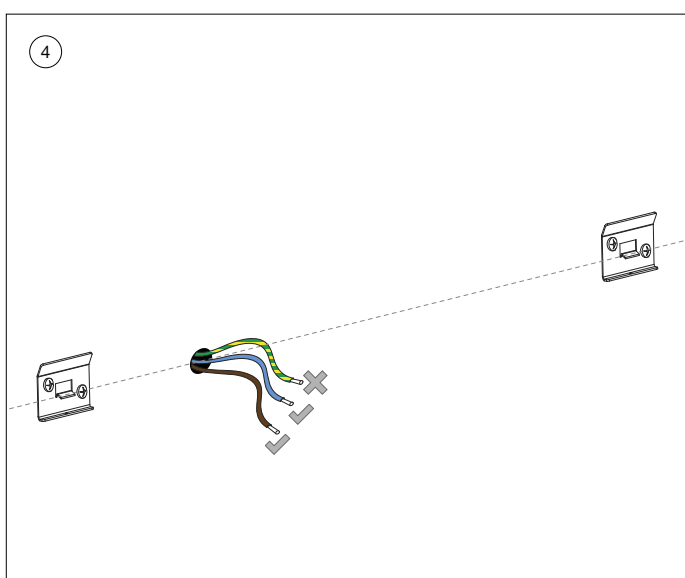
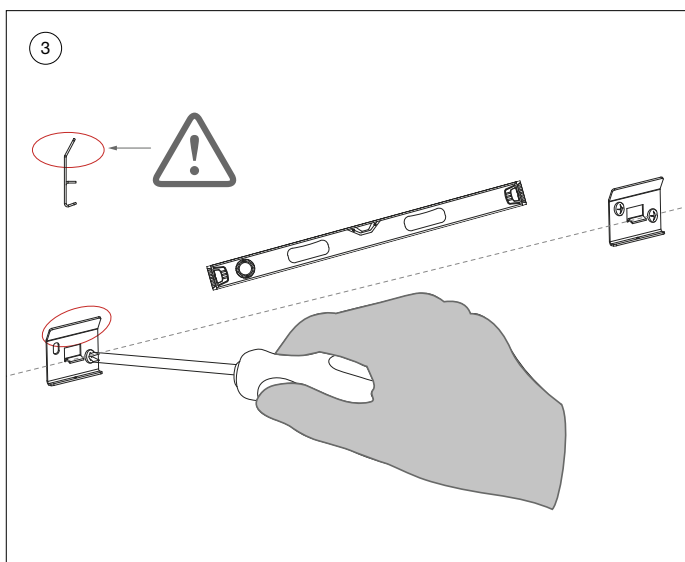

- 3 Befestigen Sie die Halterungen mit der richtigen Seite nach oben (siehe Zeichnung) an der Wand. Achten Sie darauf, dass die Oberseite beider Halterungen waagrecht ist.



**ACHTUNG: Verwenden Sie Montagematerial, das für den Wandtyp, an dem die Befestigung angebracht wird, geeignet ist.**

- 4 Entnehmen Sie die elektrischen Anschlusskabel aus der Wand. Es werden nur Phasen- und Nullleiterkabel benötigt; schirmen Sie die Erdung ab.

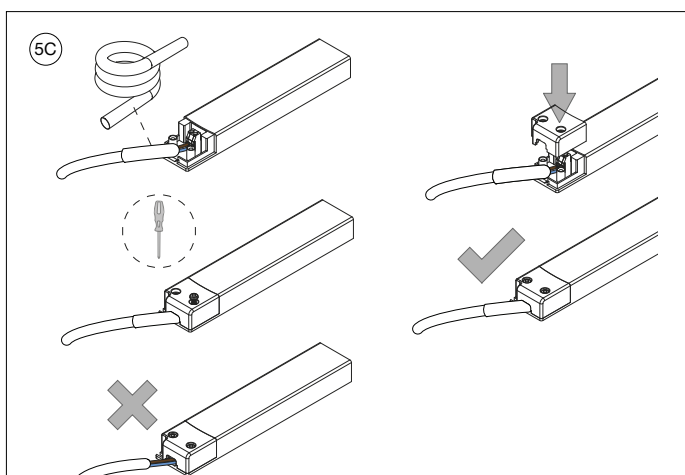
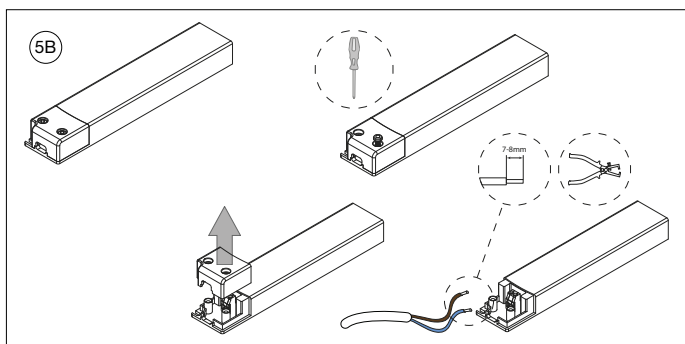
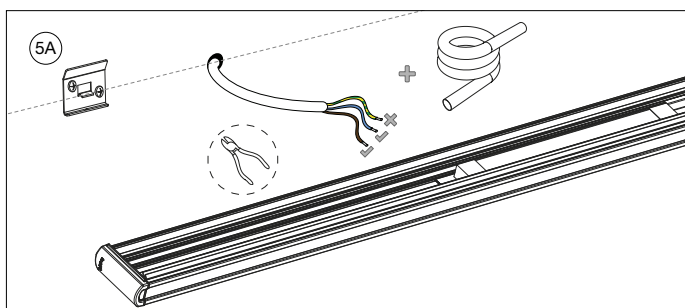

- 5A) Bereiten Sie das elektrische Kabel vor. Verwenden Sie den mitgelieferten Isolierschlauch, um das Kabel zu schützen. Schirmen Sie die Erdung ab.

- 5B) Entfernen Sie die orangefarbene Kappe von dem Driver in der Leuchte. Isolieren Sie Phasen- und Nullleiterkabel ab.

- 5C) Verwenden Sie den mitgelieferten Isolierschlauch, um die Kabel bis unter der orangefarbenen Abdeckung abzuschirmen. Schließen Sie die elektrischen Kabel gemäß den Markierungen an den Driver an. Setzen Sie die orangefarbene Kappe wieder auf den Driver.



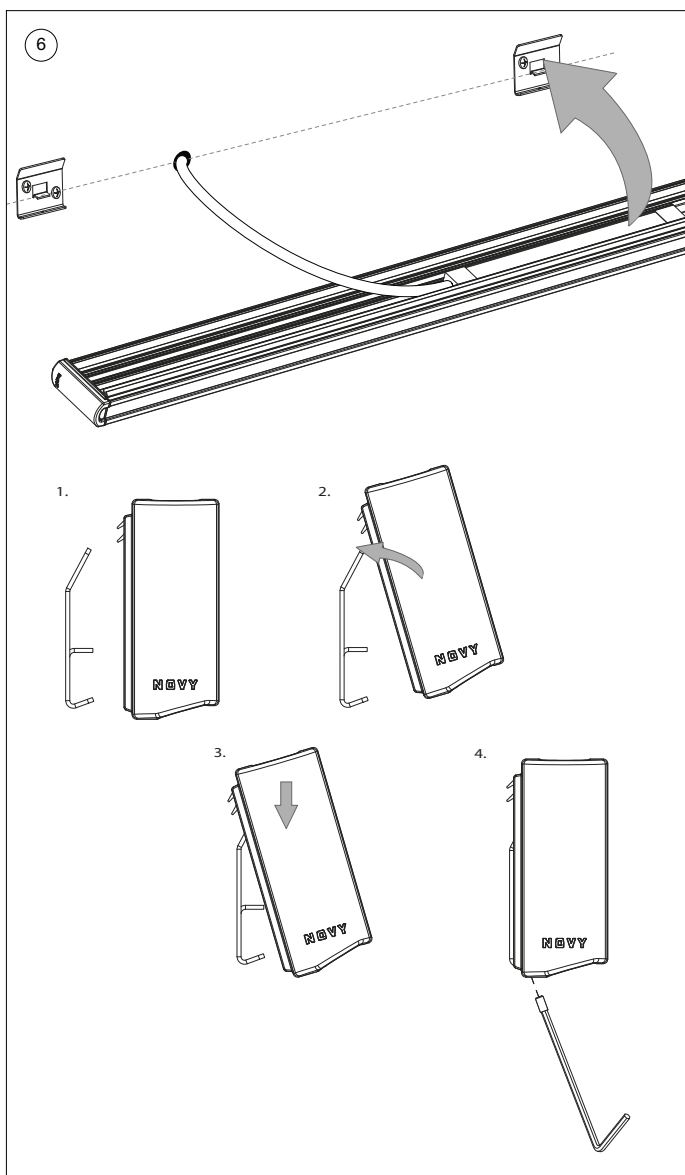

- 6 Legen Sie die Befestigung auf den Halterungen ab. Sichern Sie danach die Befestigung an den Halterungen, indem Sie die Inbusschrauben unten an den Halterungen verwenden. Schalten Sie die Stromversorgung ein. Das Gerät ist gebrauchsbereit.



**HINWEIS: Verbergen Sie falls erforderlich überschüssige Kabellängen in der Befestigung.**

# **CONTENT**

---

<b>1</b>	<b>GENERAL INFORMATION</b>	<b>27</b>
<b>2</b>	<b>INSTALLATION GUIDELINES</b>	<b>28</b>
<b>3</b>	<b>SUPPLIES</b>	<b>29</b>
<b>4</b>	<b>INSTALLATION INSTRUCTIONS</b>	<b>30</b>



# 1 GENERAL INFORMATION

These are the mounting instructions for the Novy unit device on the cover. Carefully read the safety instructions, mounting instructions and user manual before installation and putting it into operation.

The safety instructions are listed in a separate booklet supplied with the appliance and listed on our website [www.novy.com](http://www.novy.com).

Follow the safety instructions, mounting instructions and user manual to prevent injury and material damage.

This manual makes use of a number of symbols. The meaning of these symbols are given below.

Symbol	Meaning	Action
	Indication	Explanation of an indication on the device.
	Information/ Warning	This symbol indicates an important tip or a dangerous situation.

## 2 INSTALLATION GUIDELINES

 This product contains an ambient light source of energy efficiency class F.

 This product contains a functional light source of energy efficiency class E.

 The product should only be installed by a qualified and trained installer.

 Light source (LED only) can only be replaced by a certified installer.

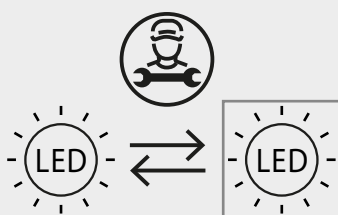

 Driver can only be replaced by a certified installer.

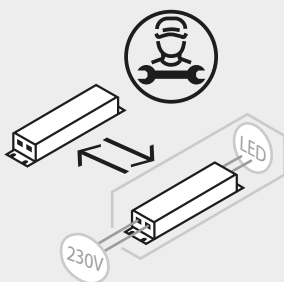

 Turn off the power to the designated power cable during installation.

 Provide an on-off switch at the mains power supply.

### 3 SUPPLIES



Check if the necessary accessories are included.

1

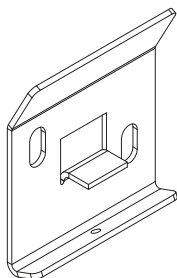

black: 2x 7000017806  
white: 2x 7000017807



black: 2x 70000191  
white: 2x 70000183

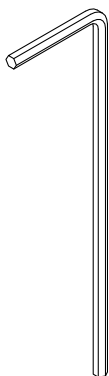

1x 53005145

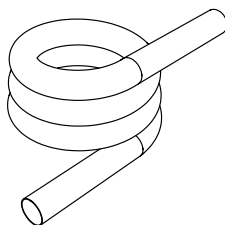

1x 70000206

## 4 INSTALLATION INSTRUCTIONS

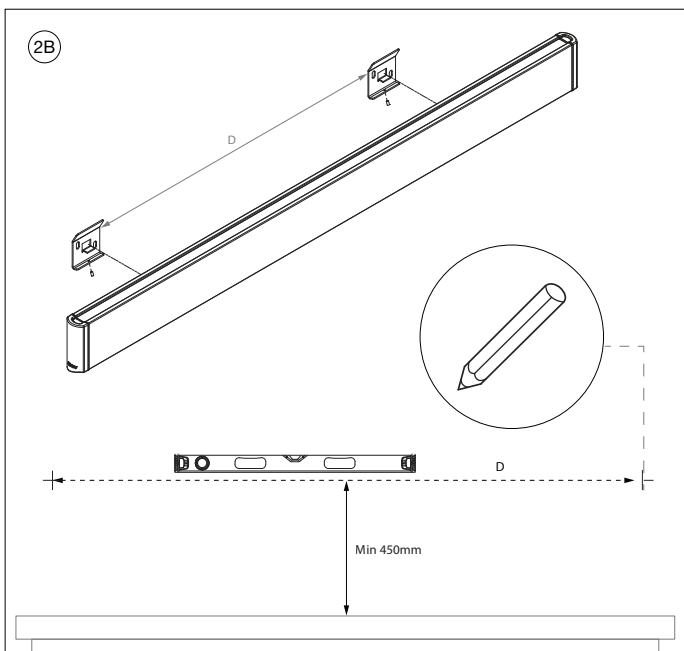
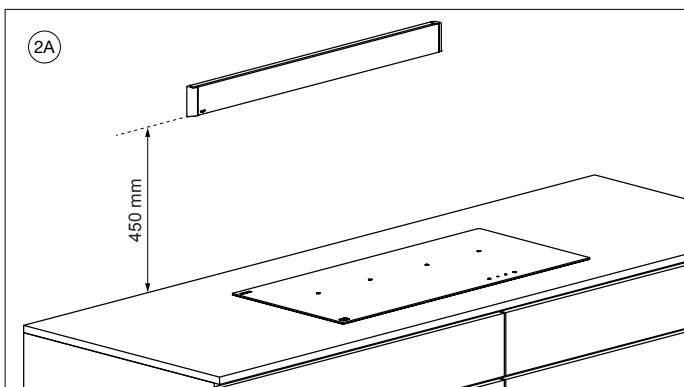

**ATTENTION:** The electrical connection from the wall cannot be provided within the first 550 mm on the right side of the fixture.

- 2A Determine the desired position of the Novy Wall. Make sure there is at least 45 cm distance between the bottom of the fixture and the worktop to ensure safety and functionality.
- 2B Mark the location of the installation brackets on the wall. The maximum distance between the brackets (center point to center point) is shown in the table.

Product	D max (mm)	Product	D max (mm)
Novy Wall 95	735	Novy Wall 215	1895
Novy Wall 125	1025	Novy Wall 245	2185
Novy Wall 155	1315	Novy Wall 275	2475
Novy Wall 185	1605	Novy Wall 305	2765

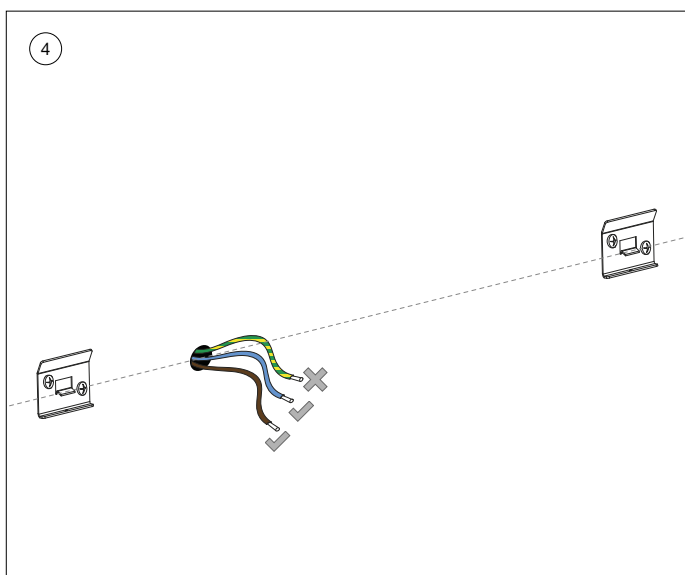
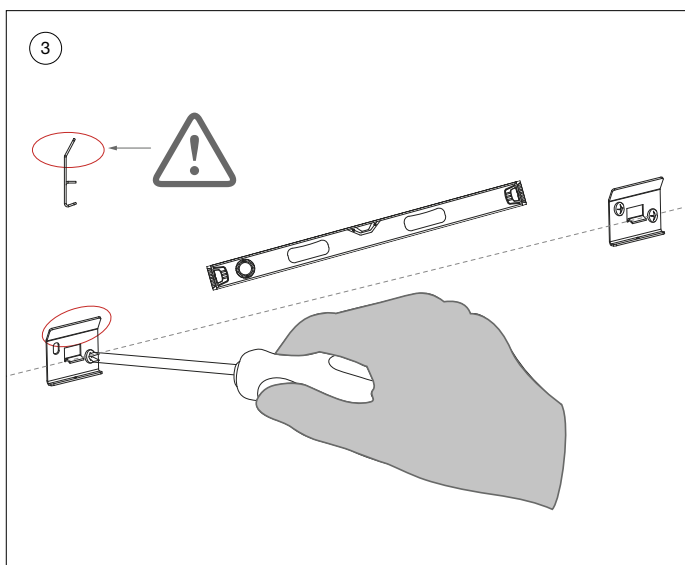

- 3 Attach the brackets, with the correct side upwarde (see drawing), to the wall. Ensure that the top of both brackets is level.



**ATTENTION: Use appropriate mounting material for the type of wall on which the fixture is being installed.**

- 4 Provide the electrical connection cable from the wall. Only line and neutral cables are needed; shield the grounding.

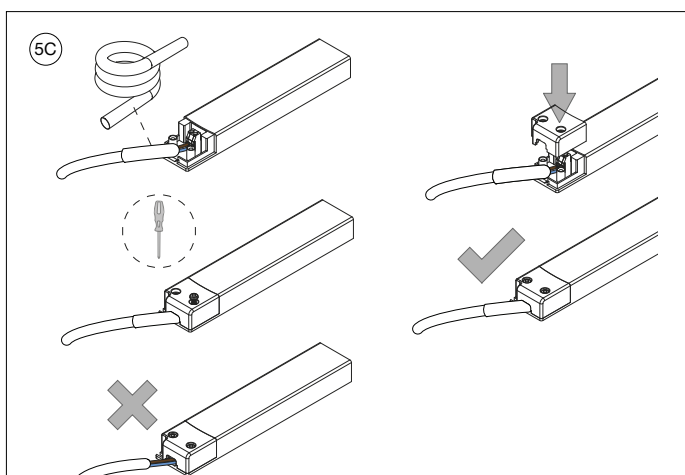
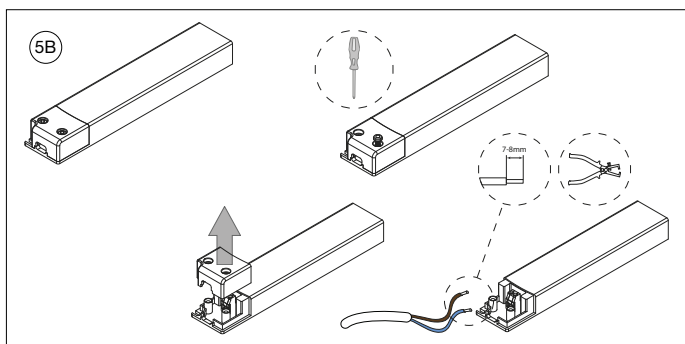
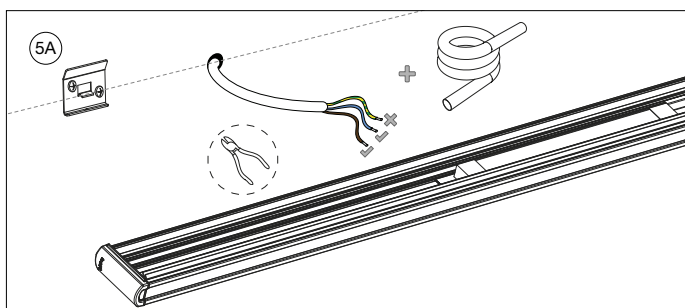

5A Prepare the electric cable. Use the insulation hose provided to protect the cable. Shield the earthing.

5B Remove the orange cap from the driver in the luminaire. Strip the line and neutral cable.

5C Use the insulation hose provided to shield the cables to below the orange cover. Connect the electrical cables according to the markings on the driver. Replace the orange cap on the driver.



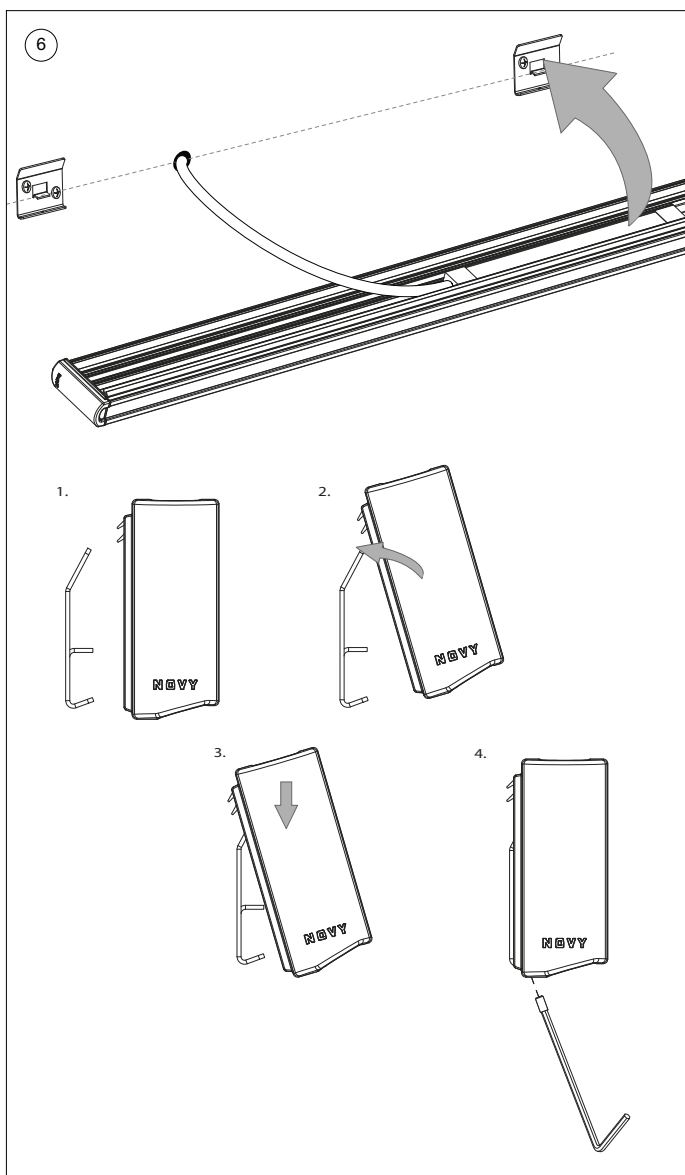

- 6 Let the fixture rest on the brackets. After that, secure the fixture to the brackets using the Allen screws at the bottom of the brackets. Switch on the power and the device is ready to use.



**ATTENTION: Conceal any excess cable inside the fixture.**

NOVY nv behoudt zich het recht voor te allen tijde en zonder voorbehoud de constructie en de prijzen van haar producten te wijzigen.

NOVY SA se réserve le droit de modifier à tout moment et sans réserve la fabrication et les prix de ses produits.

Die NOVY AG behält sich das Recht vor, zu jeder Zeit und ohne Vorbehalt die Konstruktion und die Preise ihrer Produkte zu ändern.

NOVY nv reserves the right at any time and without reservation to change the structure and the prices of its products.

**NOVY nv**

Noordlaan 6

B - 8520 KUURNE

Tel. 0032 (0) 56/36.51.00

[info@novy.com](mailto:info@novy.com)

[www.novy.com](http://www.novy.com)