

PRECAUTIONS	32	Using the accessories	42
General safety instructions	32	Using the hob	42
Installation	36	Using the storage compartment (where present)	44
Appliance purpose	37	Using the oven	45
This user manual	37	Digital programmer	46
Manufacturer's liability	37	Cooking advice	47
Identification plate	37	Cooking information table	48
Disposal	37	CLEANING AND MAINTENANCE	49
Information for European Control Bodies	38	Cleaning the appliance	49
Energy efficiency technical data	38	Cleaning the glass ceramic hob	49
To save energy	38	Knobs	50
Light sources	38	Cleaning the door	50
How to read the user manual	38	Cleaning the oven cavity	51
DESCRIPTION	39	Vapor Clean (on some models only)	52
General description	39	Extraordinary maintenance	53
Hob	39	INSTALLATION	54
Control panel	40	Positioning	54
Other parts	41	Electrical connection	56
Accessories	41	Instructions for the installer	57
USE	42		
Preliminary operations	42		

We advise you to read this manual carefully, which contains all the instructions for maintaining the appliance's aesthetic and functional qualities. For further information on the product: www.smeg.com

PRECAUTIONS

General safety instructions

Risk of personal injury

- During use the appliance and its accessible parts become very hot. Keep children well away from the appliance.
- The appliance becomes very hot during use. Make sure that you never touch the heating elements inside the oven.
- Protect your hands by wearing oven gloves when moving food inside the oven.
- Never try to put out a fire or flames with water: Turn off the appliance and smother the flames with a fire blanket or other appropriate cover.
- This appliance may only be used by children aged 8 years and over, and by people of reduced physical, sensory or mental capacity, or lacking in experience in the use of electrical appliances, provided that they are supervised or have been given instructions on the safe use of the appliance and of the hazards associated with it.
- Children must not play with the appliance.
- Keep children under the age of

- eight at a safe distance unless they are constantly supervised.
- Keep children under the age of 8 away from the appliance when it is in use.
 - Cleaning and maintenance must not be carried out by unsupervised children.
 - Be aware of how rapidly the cooking zones heat up. Do not place empty pans on the heat. Danger of overheating.
 - After use the cooking zones remain hot for a certain period of time after they have been turned off. Do not touch the hob surfaces.
 - The cooking process must always be kept under control. A short cooking process must be continuously monitored.
 - **WARNING:** Leaving food that contains fat and/ oil unattended when cooking can be dangerous and can cause a fire. **DO NOT** attempt to extinguish a fire with water. Turn off the appliance and smother the flames, for example with a lid or a blanket.
 - Do not use the Booster and/or the Double Booster functions (if present) to heat fats or oils. Fire hazard.
 - Do not place metal objects, such as dishes or cutlery, on the surface of the hob during cooking as they may overheat.
 - Do not cook foods in closed tins or containers or plastic containers.
 - Do not insert pointed metal objects (cutlery or utensils) into the slots in the appliance.
 - Do not use or store flammable materials near the appliance.
 - Do not pour water directly onto very hot trays.
 - Keep the oven door closed during cooking.
 - If you need to move food or at the end of cooking, open the door 5 cm for a few seconds, let the steam come out, then open it fully.
 - Do not open the storage compartment (where available) when the oven is on and still hot.
 - The items inside the storage compartment (where available) could be very hot after the oven has been used.
 - Switch off the appliance immediately after use.
 - Do not pull the cable to unplug the appliance (if present).
 - **DO NOT USE OR STORE FLAMMABLE MATERIALS IN THE STORAGE COMPARTMENT (IF AVAILABLE) OR NEAR THE APPLIANCE.**
 - **DO NOT USE AEROSOLS IN THE VICINITY OF THIS APPLIANCE WHILST IT IS IN USE.**
 - **DO NOT MODIFY THIS**

APPLIANCE.

- Always wear personal protective equipment (PPE) before carrying out any work on the appliance (installation, maintenance, positioning or moving).
- Do not clean the appliance if it is still hot or in operation.
- Before performing any work on the appliance, switch off the power supply.
- **WARNING:** Make sure that the appliance has been switched off and disconnected from the mains power supply or that the mains power has been switched off before replacing the interior lighting bulbs.
- The bulbs used in this appliance are specific for household appliances; do not use them for home lighting.
- Do not try to repair the appliance yourself or without the assistance of a qualified technician.
- If the power cable becomes damaged, contact technical support immediately to arrange for it to be replaced in order to avoid possible hazards.
- If cracks or fissures form, or if the glass ceramic cooking surface breaks, turn off the appliance immediately. Disconnect the power supply and call Technical Support.
- Do not touch or clean the hob

surface during operation or when the residual heat indicator lights are still on.

- Activate the controls lock when you have children or pets that could reach the hob.
- After use, switch off the plates. Never rely solely on the cookware detector.
- Supervise children carefully as they cannot readily see the residual heat indication. After use the cooking zones remain hot for a certain period of time even if they have been turned off. Keep children away from the cooking zones.
- People who have pacemakers or other similar devices fitted must make sure that the operation of these devices is not affected by the induction field, the frequency range of which is between 20 and 50 kHz.
- In conformity with the provisions regarding electromagnetic compatibility, the electromagnetic induction cooking hob comes under group 2 and class B (EN 55011).

Risk of damaging the appliance

- Do not use harsh or abrasive detergents or sharp metal scrapers to clean the glass door of the oven since they may scratch the surface and

cause the glass to shatter.

- Use wooden or plastic utensils.
- Do not use steam jets to clean the appliance.
- Do not use the appliance as a support surface.
- Do not obstruct ventilation openings and heat dispersal slots.
- Do not sit on the appliance.
- Do not rest any weight or sit on the open door of the appliance.
- Racks and trays should be inserted as far as they will go into the side guides. The mechanical safety locks that prevent them from being removed must face downwards and towards the back of the oven.

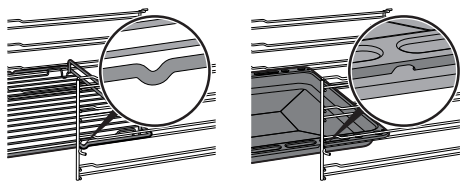

- Never leave the appliance unattended during cooking operations that could lead to oils and fats overheating and catching fire. Be very careful
- Risk of fire: Do not store objects on the cooking surfaces.
- Do not spray any spray products near the oven.
- **DO NOT FOR ANY REASON USE THE APPLIANCE AS A SPACE HEATER.**
- Do not use plastic kitchenware

- or containers for cooking.
- Do not put sealed tins or containers in the oven.
- Remove all trays and racks which are not required during cooking.
- Do not cover the bottom of the oven cavity with aluminium or tin foil sheets.
- Do not place pans or trays directly on the bottom of the oven cavity.
- If necessary, you can use the tray rack (supplied or sold separately, depending on the model) by placing it on the bottom as a support for cooking.
- If you wish to use greaseproof paper, place it so that it will not interfere with the hot air circulation inside the oven.
- Do not use the open door to rest pans or trays on the internal glass pane.
- Cooking vessels or griddle plates should be placed inside the perimeter of the hob.
- All pans must have smooth, flat bottoms.
- If any liquid does boil over or spill, remove the excess from the hob.
- Take care not to spill acid substances such as lemon juice or vinegar on the hob.
- Do not spill sugar or sweet mixtures on the hob during cooking.

- Do not place materials or substances that could melt or catch fire (paper, plastic or aluminium foil) on the appliance while it is in use.
- Do not use steam jets to clean the appliance.
- Place the cookware directly on the glass ceramic surface.
- Do not put empty pans or frying pans on switched on cooking zones.
- Do not use rough or abrasive materials or sharp metal scrapers.
- Do not use cleaning products containing chlorine, ammonia or bleach on parts made of steel or that have metallic surface finishes (e.g. anodizing, nickel- or chromium-plating).
- Do not use abrasive or corrosive detergents (e.g. scouring powders, stain removers and metallic sponges) on glass parts.
- The glass ceramic surface is highly resistant to impacts. However, avoid hard, solid objects falling on the cooking surface as they may cause it to break.
- Never use the oven door to lever the appliance into place when fitting.
- Avoid exerting too much pressure on the door when open.
- Take care that no objects are stuck in the doors.
- Do not use the handle to lift or move this appliance.
- This appliance is not intended to be operated by means of external timer or separate remote control system.
- Do not spray cleaning products directly onto the door, as they may get into areas that are difficult to access and rinse off. Over time, they may react with painted panels or steel.

Installation

- **THIS APPLIANCE MUST NOT BE INSTALLED IN BOATS OR CARAVANS.**
- This appliance must not be installed on a pedestal.
- Always use any necessary/required personal protective equipment (PPE) before performing any work on the appliance (installation, maintenance, positioning or movement).
- Position the appliance into the cabinet cut-out with the help of a second person.
- Check that the carcass has the required openings.
- Check that the carcass material is heat resistant.
- To avoid potential overheating, the appliance must not be installed behind a decorative door or a panel.
- Installation and servicing should be carried out by qualified

personnel in accordance with current standards.

- Have the electrical connection performed by authorised technical personnel.
- The appliance must be connected to earth in compliance with electrical system safety standards.
- Use cables that can withstand temperatures of at least 90°C.
- The tightening torque of the screws of the terminal supply wires must be 1.5 - 2 Nm.
- Be careful when connecting additional electrical appliances. Connection cables must not come into contact with hot cooking zones.
- The power cable must only be installed or replaced by a qualified technician.
- If the power cable becomes damaged, contact technical support immediately to arrange for it to be replaced in order to avoid possible hazards.
- Allow the appliance to be disconnected after installation, via an accessible plug or a switch in the case of a fixed connection.
- Fit the power line with an all-pole circuit breaker with a contact separation distance sufficient to provide complete disconnection in category III overvoltage conditions, pursuant to installation

regulations.

- This appliance can be used up to a maximum altitude of 2,000 metres above sea level.

Appliance purpose

This appliance is intended for cooking food in the home environment. Every other use is considered inappropriate. It cannot be used:

- in employee kitchens, shops, offices and other working environments.
- in farms/farmhouses.
- by guests in hotels, motels and residential environments.
- In bed and breakfast accommodation.

This user manual

- This user manual is an integral part of the appliance and must therefore be kept in its entirety and within the user's reach for the whole working life of the appliance.
- Read this user manual carefully before using the appliance.

Manufacturer's liability

The manufacturer declines all liability for damage to persons or property caused by:

- use of the appliance other than that specified;
- failure to comply with the instructions in the user manual;
- tampering with any part of the appliance;
- use of non-original spare parts.

Identification plate

The identification plate bears the technical data, serial number and brand name of the appliance. Do not remove the identification plate for any reason.

Disposal



This appliance conforms to the WEEE European directive (2012/19/EU) and must be disposed of separately from

other waste at the end of its service life.
The appliance does not contain substances in quantities sufficient to be considered hazardous to health and the environment, in accordance with current European directives.

 **Power voltage**
Danger of electrocution

- Disconnect the mains power supply.
- Unplug the appliance.

To dispose of the appliance:

- Cut the power cable and remove it.
- Deliver the appliance to the appropriate recycling centre for electrical and electronic equipment waste, or return it to the retailer when purchasing an equivalent product, on a one for one basis.

Our appliances are packaged in non-polluting and recyclable materials.

- Deliver the packing materials to the appropriate recycling centre.

 **Plastic packaging**
Danger of suffocation

- Do not leave the packaging or any part of it unattended.
- Do not let children play with the plastic bags.

Information for European Control Bodies

Fan forced mode

the ECO function used to define the energy efficiency class complies with the specifications of European standard EN 60350-1.

Energy efficiency technical data

Information in accordance with the European energy labelling and ecodesign regulations is contained in a separate document accompanying the product instructions.

These data are present in the "Product information sheet" that can be downloaded from the website at the page dedicated to the product in question.

To save energy

- Only preheat the appliance if the recipe requires you to do so.
- Unless otherwise indicated on the package,

defrost frozen foods before placing them in the oven.

- When cooking several types of food it is recommended to cook the foods one after the other to make the best use of the already hot oven.
- Use dark metal moulds: They help to absorb the heat better.
- Remove all trays and racks which are not required during cooking.
- Stop cooking a few minutes before the time normally used. Cooking will continue for the remaining minutes with the heat which has accumulated inside the oven.
- Reduce any opening of the door to a minimum to avoid heat dispersal.
- Keep the inside of the oven clean at all times.

Light sources

- This appliance contains user-replaceable light sources.

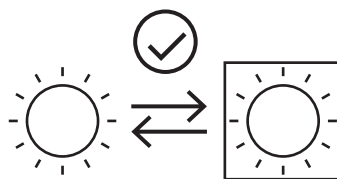

- The light sources contained in the appliance are declared suitable for operation at ambient temperature $\geq 300^{\circ}\text{C}$ and intended for use in high temperature applications such as ovens.
- This appliance contains light sources of efficiency class "G".

How to read the user manual

This user manual uses the following reading conventions:

 Warning/Caution

 Information/Advice

DESCRIPTION

General description

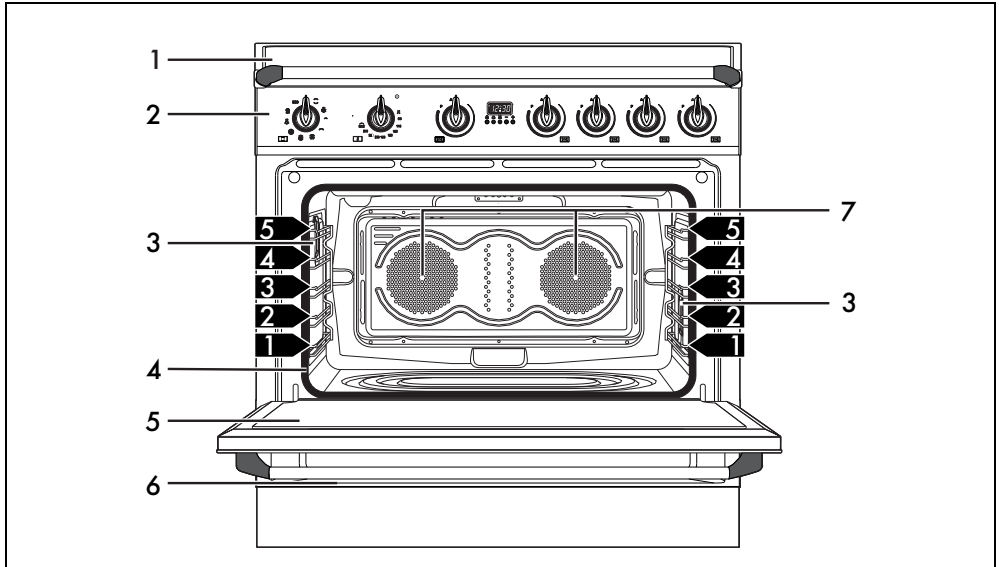

- 1 Hob
- 2 Control panel
- 3 Oven light
- 4 Seal
- 5 Door
- 6 Storage compartment
- 7 Fans
- 1,2,3** Frame shelf

Hob

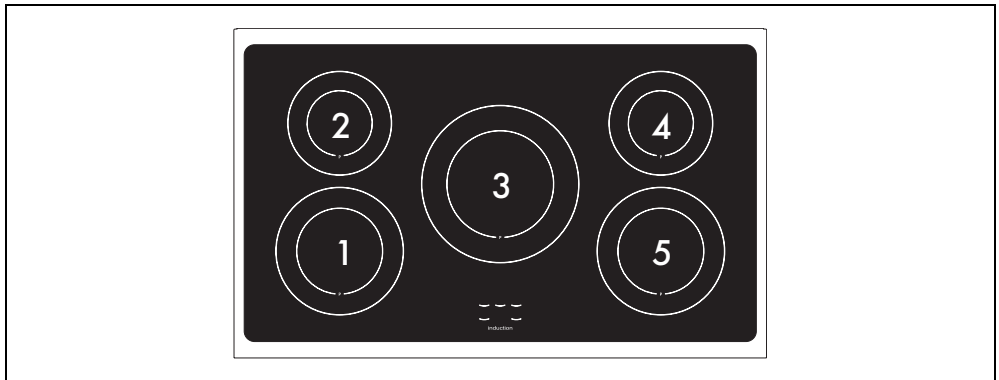

Zone	Outer diameter (mm)	Pan minimum Ø (mm)	Pan Ø shelf (mm)	Max. power draw (W)*	Power draw in Booster function (W)*
1	210	120	210	2300	3000
2	180	110	180	1300	1400
3	270	145	270	2300	3000
4	180	110	180	1300	1400

Zone	Outer diameter (mm)	Pan minimum Ø (mm)	Pan Ø shelf (mm)	Max. power draw (W)*	Power draw in Booster function (W)*
5	210	120	210	2300	3000

* power levels are indicative and can vary according to the pan used or the settings made.

Advantages of induction cooking



The appliance is equipped with an induction generator for each cooking zone. Each generator located under the glass ceramic cooking surface creates an electromagnetic field which induces a thermal current in the base of the pan. This means the heat is no longer transmitted from the hob to the pan but created directly inside the pan by the inductive current.

- Energy saving thanks to the direct transmission of energy to the pan (suitable magnetisable cookware is required) compared to traditional electric cooking.
- Improved safety as the energy is only transmitted to the pan placed on the hob.
- High level of energy transmitted from the induction cooking zone to the base of the pan.

- Rapid heating speed.
- Reduced danger of burns as the cooking surface is only heated under the base of the pan; foods which overflow do not stick.

Power control

The hob is fitted with a power control module that optimises/limits consumption. If the overall set power level exceeds the maximum limit permitted, the electronic circuit board will automatically manage the power supplied by the hot plates. The module tries to maintain the maximum deliverable power levels. Levels set by the automatic control will appear on the display.



Priority is given to the first zone that is set in chronological order.



The power control module does not affect the total power consumption of the appliance.

Control panel

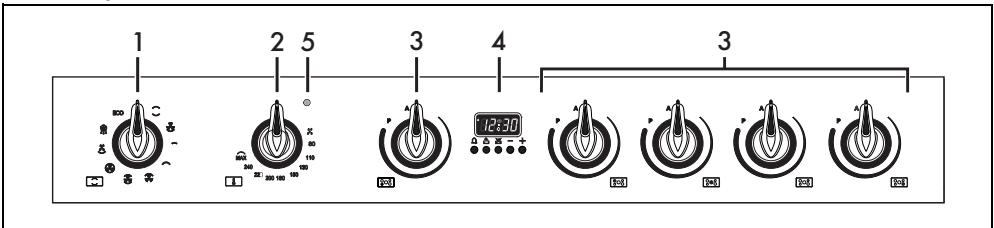

1 Function knob

The oven's various functions are suitable for different cooking modes. After selecting the required function, set the cooking temperature using the temperature knob.

2 Temperature knob

This knob allows you to select the cooking temperature. Turn the knob clockwise to the required value, between the minimum and maximum setting.

3 Hob cooking zone knobs

Useful for controlling the cooking zones of the induction hob. Press and turn the knobs clockwise to adjust the operating power of the

hot plate from a minimum of 1 to a maximum of 9. The working power is indicated on the display on the hob.

4 Programmer clock

For displaying the current time, setting programmed cooking operations and the minute minder timer.

5 Indicator light

The indicator light comes on to indicate that the oven is heating up. It turns off as soon as it reaches the set temperature. It flashes regularly to indicate that the temperature set inside the oven is kept constant.

Other parts

Shelves

The appliance features shelves to position trays and racks at different heights. The insertion heights are indicated from the bottom upwards (see General description).

Cooling fan

The fan cools the oven and comes into operation during cooking. The fan causes a steady outflow of air that exits from the rear of the appliance and which may continue for a brief period of time even after the appliance has been turned off.



Do not obstruct ventilation openings and heat dispersal slots.

Interior lighting

The appliance's interior lighting comes on:

- When the door is opened.
- When any function is selected, apart from the **Eco** function.



When the door is open, it is not possible to turn off the interior lighting.

Accessories

- Not all accessories are available on some models.
- The accessories intended to come into contact with food are made of materials that comply with the provisions of current legislation.
- Original supplied and optional accessories can be requested to Authorised Assistance Centres. Use only original accessories supplied by the manufacturer.

Oven tray

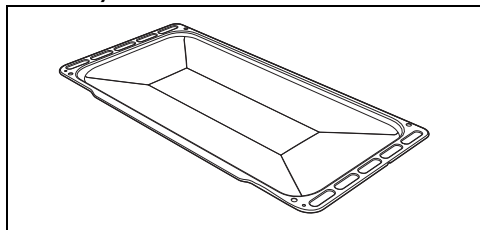

Useful for collecting fat from foods placed on the rack above and for cooking pies, pizzas, baked desserts, biscuits, etc.

Deep tray

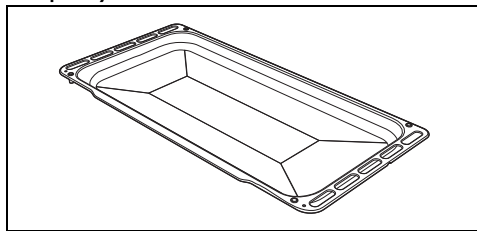

Useful for collecting fat from foods placed on the rack above.

Tray rack

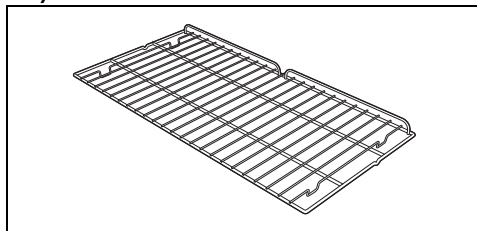

Useful for supporting containers with food during cooking.

Rack

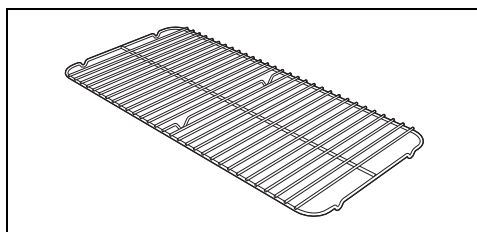

To be placed over the top of the oven tray; for cooking foods which may drip.

Self-cleaning panels (on some models only)

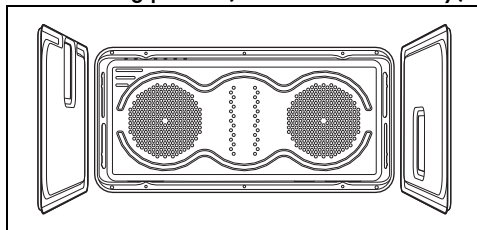

Useful for absorbing small grease residues.

USE

Preliminary operations



See General safety instructions.

- Remove any protective film from the outside or inside of the appliance, including accessories.
- Remove any labels (apart from the technical data plate) from the accessories and shelves.
- Remove and wash all the appliance accessories (see chapter "CLEANING AND MAINTENANCE").

First heating

1. Set a cooking time of at least one hour (see paragraph "Using the oven").
2. Heat the empty oven compartment at the maximum temperature to burn off any residues left by the manufacturing process.

When heating the appliance

- air the room;
- don't stay.

Using the accessories

Racks and trays

Racks and trays have to be inserted into the side guides until they come to a complete stop.

- The mechanical safety locks that prevent the rack from being removed accidentally must face downwards and towards the back of the oven cavity.

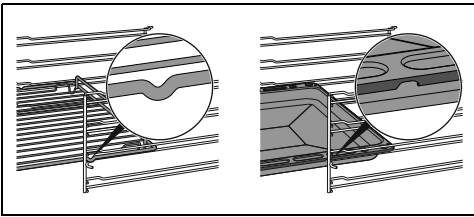

Gently insert racks and trays into the oven until they come to a stop.



Clean the trays before using them for the first time to remove any residues left by the manufacturing process.

Tray rack

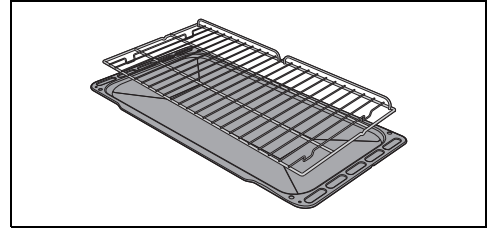

The tray rack has to be inserted into the tray. In this way fat can be collected separately from the food which is being cooked.

Using the hob

All the appliance's control and monitoring devices are located together on the front panel. The relevant cooking zone is indicated next to each knob. Just turn the knob clockwise to the required power setting.



On first connection to the electrical mains, an automatic check will be carried out that will switch on all indicator lights for a few seconds.



After use, turn off the hot plates that were used by moving the relative knob back to position 0. Never rely solely on the cookware detector.

Cookware suitable for use in induction cooking

Cookware used on the induction cooking surface must be made of metal, with magnetic properties and a sufficiently large base.

Suitable cookware:

- Enamelled steel cookware with thick bases.
- Cast iron cookware with an enamelled base.
- Cookware in multilayer stainless steel, ferritic stainless steel and aluminium with a special base.

Unsuitable cookware:

- Copper, stainless steel, aluminium, fireproof glass, wood, ceramic and terracotta cookware.

To see whether the pan is suitable, bring a magnet close to the bottom: if it is attracted, the pan is suitable for induction cooking. If you do

not have a magnet, you can put a small amount of water in the pan, place it on a cooking zone and start the hot plate. If the **H** symbol appears on the display, it means the pan is not suitable.

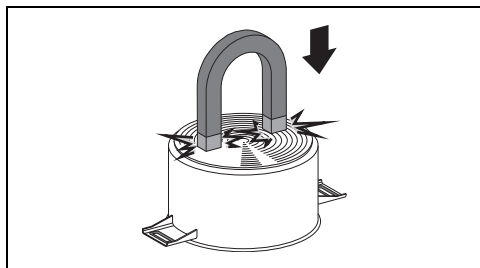

Use only cookware with a perfectly flat bottom which is suitable for induction hot plates. Using cookware with an irregular bottom could jeopardise the efficiency of the heating system and prevent cookware from being detected on the hot plate.

Cookware recognition

When there is no saucepan on a cooking zone or if the saucepan is too small, no energy will be transmitted and the **H** symbol will appear on the display. If there is a suitable saucepan on the cooking zone, the recognition system detects it and switches on the hob to the power level set using the knob. Energy transmission is also interrupted when the saucepan is removed from the cooking zone (the **H** symbol will be shown on the display). If the cookware recognition function is activated in spite of the saucepan or frying pan on the cooking zone being smaller than the zone itself, only the necessary energy will be transmitted.

Saucepan recognition limits

The minimum diameter of the pan base is indicated by the cross on the cooking zone. Pans with smaller diameters risk not being detected and therefore not activating the inductor.

Limiting the cooking duration

The hob has an automatic device which limits the duration of use. If the cooking zone settings are not changed, the maximum duration of operation for each zone depends on the power level selected. When the device for limiting the duration of use is activated, the cooking zone

turns off, a short alert sounds and, if the zone is hot, the **H** symbol appears on the display.

Set power level	Maximum cooking duration in hours
1	8
2	6
3 - 4	5
5	4
6 - 7 - 8 - 9	1.5

Protection from overheating

If the hob is used on full power for a long period, the electronics will have trouble cooling down if the room temperature is high. To avoid excessively high temperatures forming in the electronics, the power to the cooking zone is reduced automatically.

Residual heat

If the cooking zone is still hot after being switched off, the **H** symbol will be displayed on the display. The symbol clears once the temperature drops below 60°C.

Heating accelerator



Each cooking zone is equipped with a heating accelerator that allows the maximum power to be delivered for a time that is proportional to the selected power.

This function allows the selected power to be achieved in the shortest amount of time.

1. Turn the knob anticlockwise to position A and then release it. The display shows the **A** symbol.
2. Select the required heating power (1..8) within 3 seconds. The selected power and the **A** symbol will flash alternately on the display.

The power level can be increased at any moment. The "maximum power" period will automatically be modified. Once the acceleration period is over the power level will remain the same as the one previously selected.



If the power is reduced, by turning the knob anti-clockwise, the heating accelerator will automatically be disabled.

Booster function

The booster function allows the cooking zone to be activated at maximum power for as long as 5 minutes. It can be used to bring a large quantity of water to a boil rapidly or to broil meat.

- To activate the Booster function, turn the knob clockwise to position P, keep it there until the **P** symbol appears on the corresponding display and then release the knob.
- After 5 minutes of continuous operation, the Booster function will be disabled automatically and cooking will continue at power level 9.
- Select any other power level to deactivate the Booster function.

Only for some zones: the Booster function is always enabled and has to be disabled manually using the corresponding knob.



The Booster function has priority over the heating Accelerator function.

Keep warm



The Keep warm function allows you to keep cooked food warm.

To activate the Keep Warm function turn the knob of the required zone to an intermediate position between 0 (off) and power level 1, until the **W** symbol appears on the corresponding display.

Hob power limitation

The induction hob is configured to operate at 7.4 kW, but it can be set to operate at 4.8 kW or 3.7 kW.

1. Disconnect the appliance from the mains power supply and wait 10 seconds before turning the power back on.



The hob power limitation must be set within 2 minutes of it being connected to the mains power supply.

2. Turn the front left and front right cooking zone knobs anticlockwise at the same time (to position "A" respectively), and keep them in this position for 3 seconds.

The rear left and rear right cooking zone displays indicate "7." and "4" (power 7.4 kW).

3. Release the knobs.

4. Repeat steps 2 and 3 to change the power limitation until "4." and "8" (4.8 kW power) or "3." and "7" (3.7 kW power) appear on the respective displays.

After having released the knobs on the required power level, wait until the displays turn off to save the changes.



The power level can be changed again up to 4 minutes after the displays have turned off, without having to disconnect the appliance from the power supply.



The last power setting will remain valid even in the event of a power failure.

Controls lock

The controls lock is a device that protects the appliance from accidental or inappropriate use.

1. With all cooking zones switched off, turn the two knobs corresponding to the front and rear left zones to position "A".
2. Keep them turned until the **L** symbols appear on the display.
3. Release the knobs.

In order to remove the controls lock, repeat the same operations that were described previously.



After a prolonged period of interruption to the power supply, the control lock will be deactivated. In this case, activate it as described above.

Error codes

The **E** symbol indicates that one or more knobs have been held in the "A" positions for more than 30 seconds. Release the knobs to make the error message disappear. If the display shows error code **E1** or **E2**, contact technical assistance.

Using the storage compartment (where present)



See General safety instructions.

The storage compartment is in the bottom of the cooker. To open it, pull it towards you. It can be used to store cookware or metallic objects necessary when using the appliance.

Using the oven



See General safety instructions.



Switching on the oven

To switch on the oven:

1. Select the cooking function using the function knob.
2. Select the temperature using the temperature knob.



Ensure that the programmer clock shows the cooking duration symbol , otherwise it will not be possible to turn on the oven.

Press the  and  buttons at the same time to reset the programmer clock.

List of traditional cooking functions



Not all functions are available on some models.

STATIC



Traditional cooking, ideal for preparing a single dish. For example cooking roast meats, fatty meats, bread, pies.

CIRCULAIRE + BOTTOM



Allows you to quickly finish cooking food that is already cooked on the surface but not internally. Ideal for quiches, suitable for all kinds of dishes.

SMALL GRILL



Using only the heat released from the central element, this function allows you to grill small portions of meat and fish for making kebabs, toasted sandwiches and any types of grilled vegetable side dishes.

GRILL



Produces excellent grilling and gratinating results. When used at the end of cooking, gives a uniform browning to dishes.

FAN WITH GRILL



Allows optimal grilling, even for thick slices of meat. Perfect for larger cuts of meat.

FAN ASSISTED



Intense and uniform cooking. Ideal for biscuits, cakes and cooking on more than one level.

CIRCULAIRE



The heat is distributed quickly and uniformly. Suitable for all dishes, ideal for cooking on multiple levels without mixing smells or flavours.

RAPID DEFROST



Rapid defrost is helped by the activation of a fan to ensure uniform distribution of room temperature air inside the oven. Perfect for any type of food.

BOTTOM HEAT



The heat comes from the bottom of the cavity. Perfect for cakes, pies, tarts and pizzas.

ECO

ECO

This function is particularly suitable for cooking on a single shelf with low energy consumption. It is recommended for all types of food except those that may produce a large amount of moisture (e.g. vegetables). To obtain maximum energy savings and reduce cooking times, it is recommended to place food in the oven without preheating.



When using the ECO function, avoid opening the door during cooking.



Cooking (and preheating) times are longer with the ECO function and may depend on the amount of food in the oven.

VAPOR CLEAN (on some models only)



This function facilitates cleaning using the steam produced by a small amount of water poured onto the depression on the bottom.

Digital programmer







 Minute minder timer button

 Cooking duration button

 End of cooking button

 Value decrease button





 Value increase button

 Ensure that the programmer clock shows the cooking duration symbol , otherwise it will not be possible to turn on the oven. Press the  and  buttons at the same time to reset the programmer clock.

Setting the time

 If the time is not set, the oven will not switch on.







On the first use, or after a power failure, the digits  will be flashing on the appliance's display.

1. Press the  and  buttons at the same time. The dot between the hours and the minutes flashes.
2. The time can be set using the  and  buttons. Keep the button pressed in to increase or decrease rapidly.
3. Wait 5 seconds. The dot between the hours and the minutes stops flashing.
4. The  symbol on the display indicates that the appliance is ready to start cooking.

Timed cooking



Timed cooking is the function which allows a cooking operation to be started and then ended after a specific length of time set by the user.

1. After selecting a cooking function and temperature, press the  button.
2. Use the  or  button to set the duration.
3. Wait approx. 5 seconds without pressing any button in order for the function to activate. The current time and the  and **A** symbols will appear on the display.
4. At the end of cooking the heating elements will be deactivated. On the display, the  symbol turns off, the **A** symbol flashes and the buzzer sounds.
5. To turn the buzzer off, simply press one of the programmer clock buttons.
6. Press the  and  buttons at the same time to reset the programmer clock.





It is not possible to set a cooking time of more than 10 hours.



To display the remaining cooking time, press the  button.





To reset the program, press the  and  buttons at the same time. The oven will then have to be switched off manually.

Programmed cooking









Programmed cooking is the function that allows timed cooking to be stopped at a time set by the user.

1. Set the cooking time as described in the previous point Timed cooking.
2. Press the  button. The cooking end time will appear on the display (current time plus cooking duration).
3. Press the  or  button to set the cooking end time.
4. Wait approx. 5 seconds without pressing any button in order for the function to

activate. The current time and the **A** symbol appear on the display.

- At the end of cooking the heating elements will be deactivated. On the display, the  symbol turns off, the **A** symbol flashes and the buzzer sounds.







 To reset the program, press the  and  buttons at the same time. The oven will then have to be switched off manually.

 To display the remaining cooking time, press the  button. To display the end of cooking time, press the  button.

Minute minder timer

 The minute minder timer does not stop the cooking operation but rather informs the user when the set time has run out.



The minute minder timer can be activated at any time.

- Pressing button  causes  to appear on the display and the light  flashes.
- Use the  or  button to set the duration.
- Wait approx. 5 seconds without pressing any button to finish setting the minute minder. The current time and the  and  symbols appear on the display.

A buzzer will sound when the set time is reached.

- Press the decrease  button to turn the buzzer off.

 The minute minder timer can be set from 1 minute to a maximum of 23 hours and 59 minutes.

 To display the time remaining, press the  button.

Deleting the set data

Press the  and  buttons at the same time to reset the programs set.

Setting the volume of the buzzer

The buzzer can have 3 tones.

When the buzzer is in operation, press the  button to change the setting.

Cooking advice

General advice

- Use a fan assisted function to achieve consistent cooking at several levels.
- It is not possible to shorten cooking times by increasing the temperature (the food could be overcooked on the outside and undercooked on the inside).

Advice for cooking meat

- Cooking times vary according to the thickness and quality of the food and to consumer taste.
- Turn the food to brown on both sides.
- Use a meat thermometer when roasting meat, or simply press on the roast with a spoon. If it is hard, it is ready; if not, it needs to be cooked for a few more minutes.

Advice for cooking with the Grill

- Meat can be grilled even when it is put into the cold oven or into the preheated oven if you wish to change the effect of the cooking.
- With the Fan with grill function (if present), we recommend that you preheat the oven before grilling.
- We recommend placing the food at the centre of the rack.
- With the Grill function, we recommend that you set the temperature to the maximum value to optimise cooking.

Advice for cooking desserts/pastries and biscuits

- Use dark metal moulds: They help to absorb the heat better.
- The temperature and the cooking time depend on the quality and consistency of the dough.
- To check whether the dessert is cooked right through: At the end of the cooking time, put a toothpick into the highest point of the dessert. If the dough does not stick to the toothpick, the dessert is cooked.
- If the dessert collapses when it comes out of the oven, on the next occasion reduce the set temperature by about 10°C, selecting a longer cooking time if necessary.

Advice for cooking on two shelves:

- We recommend using two racks (they can be obtained from Authorised Assistance Centres).
- To facilitate the flow of air, place the moulds/ovenware at the centre of the racks and make sure that their width/diameter does not exceed 30 cm.
- Position the racks keeping an empty shelf between them.
- Depending on the type of food and the increased quantity in the oven, cooking on two levels may take slightly longer compared to cooking on a single shelf.
- We suggest using the following functions when cooking on two shelves: CIRCULAIRE

and CIRCULAIRE+BOTTOM.

Advice for defrosting and proving

- Place frozen foods without their packaging in a lidless container on the first shelf of the oven.
- Avoid overlapping the food.
- To defrost meat, use the rack placed on the second level and a tray on the first level. In this way, the liquid from the defrosting food drains away from the food.
- The most delicate parts can be covered with aluminium foil.
- For successful proving, a container of water should be placed in the bottom of the oven.

Cooking information table

Food	Weight (Kg)	Function	Shelf	Temp. (°C)	Time (minutes)	
Lasagne	3 - 4	STATIC	1	220 - 230	45 - 50	
Pasta bake	3 - 4	STATIC	1	220 - 230	45 - 50	
Veal roast	2	TURBO/CIRCULAIRE	2	180 - 190	90 - 100	
Pork loin	2	TURBO/CIRCULAIRE	2	180 - 190	70 - 80	
Sausages	1.5	FAN WITH GRILL	4	260	15	
Roast beef	1	TURBO/CIRCULAIRE	2	200	40 - 45	
Roast rabbit	1.5	CIRCULAIRE	2	180 - 190	70 - 80	
Turkey breast	3	TURBO/CIRCULAIRE	2	180 - 190	110 - 120	
Roast pork neck	2 - 3	TURBO/CIRCULAIRE	2	180 - 190	170 - 180	
Roast chicken	1.2	TURBO/CIRCULAIRE	2	180 - 190	65 - 70	
					1st surface	2nd surface
Pork chops	1.5	FAN WITH GRILL	4	260	15	5
Spare ribs	1.5	FAN WITH GRILL	4	260	10	10
Bacon	0.7	GRILL	5	260	7	8
Pork fillet	1.5	FAN WITH GRILL	4	260	10	5
Beef fillet	1	GRILL	5	260	10	7
Salmon trout	1.2	TURBO/CIRCULAIRE	2	150 - 160	35 - 40	
Monkfish	1.5	TURBO/CIRCULAIRE	2	160	60 - 65	

The times indicated in the table do not include preheating times and are provided only as a guide.

Food	Weight (Kg)	Function	Shelf	Temp. (°C)	Time (minutes)
Turbot	1.5	TURBO/CIRCULAIRE	2	160	45 - 50
Pizza	1	TURBO/CIRCULAIRE	2	260	8 - 9
Bread	1	CIRCULAIRE	2	190 - 200	25 - 30
Focaccia	1	TURBO/CIRCULAIRE	2	180 - 190	20 - 25
Bundt cake	1	CIRCULAIRE	2	160	55 - 60
Tart	1	CIRCULAIRE	2	160	35 - 40
Ricotta cake	1	CIRCULAIRE	2	160 - 170	55 - 60
Jam tarts	1	TURBO/CIRCULAIRE	2	160	20 - 25
Paradise cake	1.2	CIRCULAIRE	2	160	55 - 60
Profiteroles	1.2	TURBO/CIRCULAIRE	2	180	80 - 90
Sponge cake	1	CIRCULAIRE	2	150 - 160	55 - 60
Rice pudding	1	TURBO/CIRCULAIRE	2	160	55 - 60
Brioches	0.6	CIRCULAIRE	2	160	30 - 35

The times indicated in the table do not include preheating times and are provided only as a guide.

CLEANING AND MAINTENANCE

Cleaning the appliance



See General safety instructions.

Cleaning the surfaces

To keep the surfaces in good condition, they should be cleaned regularly after use. Let them cool first.

Ordinary daily cleaning

Always and only use specific products that do not contain abrasives or chlorine-based acids. Pour the product onto a damp cloth and wipe the surface, rinse thoroughly and dry with a soft cloth or a microfibre cloth.

Food stains or residues

Do not use steel sponges and sharp scrapers as they will damage the surface.

Use normal, non-abrasive products and a wooden or plastic tool, if necessary. Rinse thoroughly and dry with a soft cloth or a

microfibre cloth.

Do not allow residues of sugary foods (such as jam) to set inside the oven. If left to set for too long, they might damage the enamel lining of the oven.

Cleaning the glass ceramic hob



See General safety instructions.

Clean and maintain the hob using an ordinary glass ceramic cleaning product. Always follow the manufacturer's instructions. The silicon in these products creates a protective, water-repellent membrane which also resists dirt. All marks stay on the membrane and can therefore be removed easily. After cleaning, dry the surface with a clean cloth. Make sure that there is no detergent left on the cooking surface as it might undergo an aggressive reaction when heated up and could modify the structure of the cooking surface.

Food stains or residues

Light coloured marks from pans with aluminium bases can be easily cleaned off with a cloth moistened in vinegar. Remove any burnt-on residues after cooking; then rinse with water and dry thoroughly with a clean cloth. Dirt, which may have fallen on the hob while cleaning lettuce or potatoes, can scratch the hob when moving pans. Consequently, remove any dirt from the cooking surface immediately. Changes in colour do not affect the operation and stability of the glass. These are not alterations to the material of the hob but just residues which have not been removed and have then carbonised. Shiny surfaces can form due to the bases of pans, especially aluminium ones, rubbing on the surface, and due to the use of unsuitable detergents. They are difficult to remove using conventional cleaning products. It may be necessary to repeat the cleaning process several times. Use of corrosive detergents or rubbing of pan bases can wear away the decoration on the hob over time and contribute to the formation of stains.



We recommend the use of cleaning products distributed by the manufacturer.



After cleaning, dry the appliance thoroughly to prevent any water or detergent from interfering with its operation or creating unsightly marks.

Knobs



Do not use aggressive products containing alcohol or products for cleaning steel and glass when cleaning the knobs, as these products could cause permanent damage.

The knobs should be cleaned with a soft cloth dampened with lukewarm water, then dried carefully. They can be removed by pulling them out from their housings.

Cleaning the door

Cleaning the door glazing

The glass in the door should always be kept thoroughly clean. Use absorbent kitchen roll. In case of stubborn dirt, wash with a damp sponge and an ordinary detergent.

Removing the door (auxiliary oven only)

For easier cleaning it is recommended to remove the door and place it on a tea towel.

To remove the door proceed as follows:

1. Open the door completely and insert two pins into the holes on the hinges indicated in the figure.

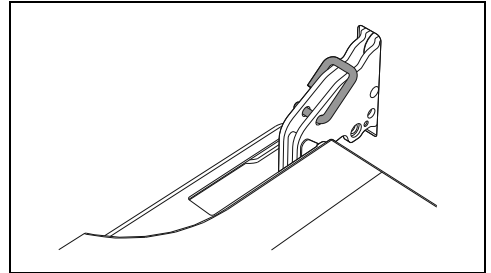

2. Grasp the door on both sides with both hands, lift it so that it forms an angle of around 30° and remove it.

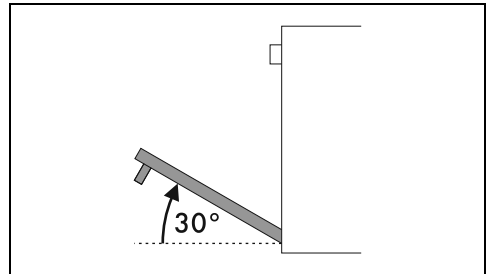

3. To reassemble the door, put the hinges in the relevant slots in the oven, making sure that grooved sections **A** are resting completely in the slots.

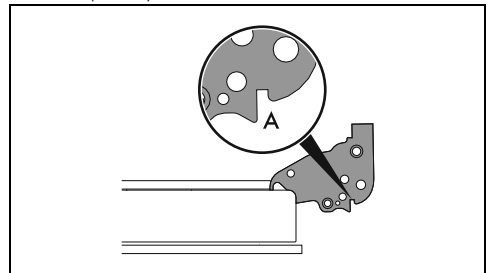

4. Lower the door and once it is in place remove the pins from the holes in the hinges.

Removing the internal glass panes

For easier cleaning the internal glass panes of the door can be removed.

1. Open the door.
2. Position the retaining pins in the holes in the hinges in order to prevent the accidental

closing of the door (see section "Removing the door").

3. Pull the rear part of the internal pane of glass gently upwards, following the movement indicated by the arrows (1). Remove the internal pane of glass from the front (2) to remove it from the door.

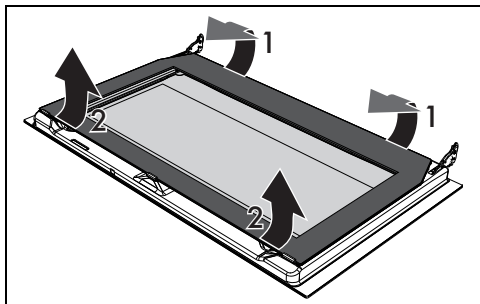

4. Remove the intermediate glass pane by lifting it upwards.

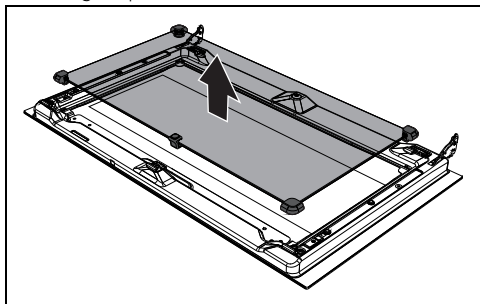

Some models have two intermediate glass panes.

5. Clean the external glass pane and the panes removed previously. Use absorbent kitchen roll. In case of stubborn dirt, wash with a damp sponge and neutral detergent.

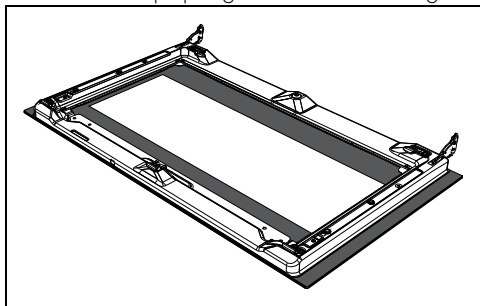

6. When you have finished cleaning, reinsert the intermediate glass pane in its housing in the door.

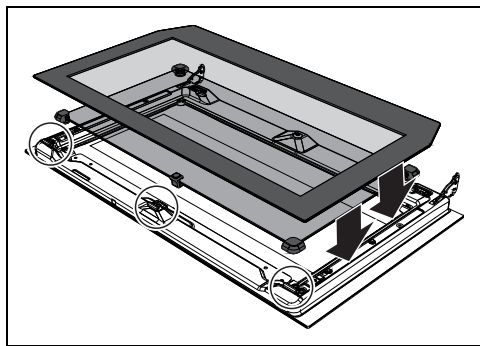

7. To replace the internal glass pane, slide the front part into the door clips and insert the 2 rear pins into their seats by pressing lightly.

Cleaning the oven cavity

In order to keep your oven in the best possible condition, clean it regularly after letting it cool down.

Avoid letting food residue dry inside the oven cavity, as this could damage the enamel.

Take out all removable parts before cleaning.

For easier cleaning, it is recommended to remove:

- the door;
- The rack/tray support frames.



In the event you are using specific cleaning products, we recommend running the oven at maximum temperature for 15-20 minutes in order to eliminate any residue.

Drying

Cooking food generates moisture inside the appliance. This is a normal phenomenon and does not affect the appliance's operation in any way.

Each time you finish cooking:

1. Let the appliance cool down.
2. Remove any dirt from inside the appliance.
3. Dry the interior of the appliance with a soft cloth.
4. Leave the door open until the inside of the appliance has dried completely.

Regenerating the self-cleaning panels (on some models only)

The regeneration cycle of the self-cleaning panels (catalytic cycle) is a cleaning method

that uses heat to remove light grease residues. It does not remove sugar-based residues.

1. First clean the base and the top of the oven cavity using a microfibre cloth soaked in water and neutral washing up liquid. Rinse thoroughly.
2. Set a regeneration cycle by selecting a fan assisted function at the maximum temperature for one hour.
3. If the self-cleaning panels are particularly dirty after the regeneration cycle, remove them and wash them with neutral washing up liquid. Rinse and dry them.

Put the self-cleaning panels back in the oven and use a fan assisted function at 180°C for an hour to ensure that they are thoroughly dry.



We recommend carrying out the self-cleaning panel regeneration cycle every 15 days.

Removing self-cleaning panels and rack/tray support frames (on some models only)

Removing the side self-cleaning panels and the rack/tray support frames enables the sides to be cleaned more easily. This should be done each time the automatic cleaning cycle is used (on some models only).

To remove the rack/tray support frames:

- Pull the frame towards the inside of the oven cavity to release it from its groove A. Then slide it out of the seats at the back B. The side self-cleaning panel is attached to the rack/tray support frame.

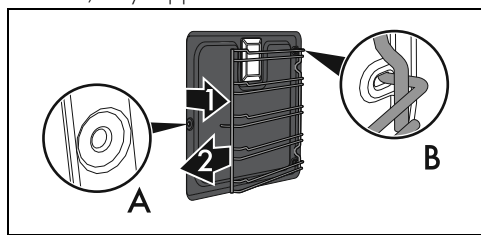

During the removal take care not to detach the self-cleaning panel from the rack/tray support frame accidentally to avoid damaging the surfaces.

- After cleaning, repeat the above procedure to put the self-cleaning side panels and rack/tray support frames back.

Vapor Clean (on some models only)



See General safety instructions.



The Vapor Clean function is an assisted cleaning procedure that facilitates the removal of dirt. Thanks to this process, it is possible to clean the inside of the oven very easily. The dirt residues are softened by the heat and water vapour for easier removal afterwards.

Preliminary operations

Before starting the **Vapor Clean** cycle:

- Completely remove all accessories from inside the oven.
- Remove the temperature probe, if present.
- Remove the self-cleaning panels, if present.
- Pour approx. 120 cc of water onto the floor of the oven. Make sure it does not overflow out of the cavity.
- Spray a water and washing up liquid solution inside the oven using a spray nozzle. Direct the spray towards the side walls, upwards, downwards and towards the deflector.





We recommend spraying approx. 20 times at the most.



Do not spray the deflector if it has a self-cleaning coating.

- Close the door.
- During the assisted cleaning cycle, wash the self-cleaning panels (where fitted), which were previously removed, separately in warm water and a small amount of detergent.

Vapor Clean cycle setting

1. Turn the functions knob to symbol  or  (where present).
2. Turn the temperature knob to the  symbol.
3. Allow the cleaning cycle to run for 18 minutes.

Vapor Clean End

1. Turn the function knob to 0 to exit from the function.
2. Open the door and wipe away the less stubborn dirt with a microfibre cloth.

3. Use a non-scratch sponge with brass filaments on hard to remove deposits.
4. In case of grease residues use specific oven cleaning products.
5. Remove the residual water inside the oven.
6. Replace the self-cleaning panels and the rack/tray support frames, if fitted.

For greater hygiene and to avoid foods taking on unpleasant odours:

- We recommend drying the inside of the oven with a fan assisted function at 160°C for around 10 minutes.
- If self-cleaning panels are fitted, we recommend that you dry the inside of the oven with a simultaneous catalytic cycle.

 We recommend wearing rubber gloves for these operations.

 We recommend removing the door in order to make the manual cleaning of the parts that are difficult to reach easier.

Extraordinary maintenance

Seal maintenance tips

The seal should be soft and elastic.

- To keep the seal clean, use a non-abrasive sponge and wash with lukewarm water.

Replacing the internal light bulb

 **Power voltage
Danger of electrocution**

- Unplug the appliance.
- Wear protective gloves.

1. Completely remove all accessories from inside the oven.
2. Remove the rack/tray support frames.
3. Use a tool (e.g. a spoon) to remove the bulb cover.

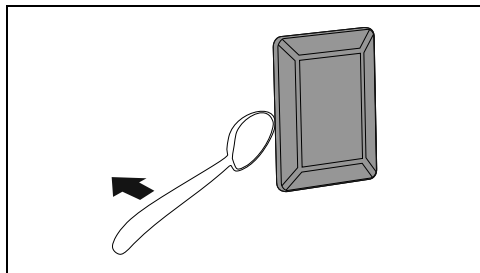

 Take care not to scratch the enamel of the oven cavity wall.

4. Slide out and remove the light bulb.

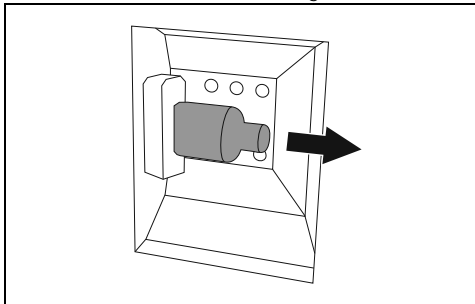

 Do not touch the halogen light bulb directly with your fingers, use an insulating material.

5. Replace the light bulb with one of the same type (40 W).
6. Refit the cover. Ensure the moulded part of the glass (A) is facing the door.

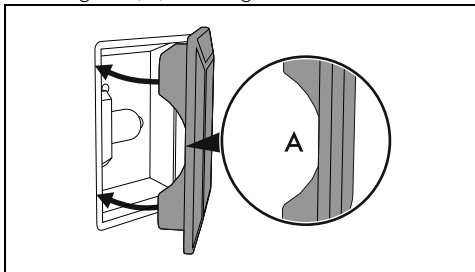

7. Press the cover completely down so that it attaches perfectly to the bulb support.

INSTALLATION



The appliance must be installed by a qualified technician and according to the regulations in force.

Positioning



See General safety instructions.

Depending on the type of installation, this appliance belongs to classes:

Class 1	Free-standing
Class 2 - subclass 1	Built-in

The appliance can be placed against walls that are higher than the work surface, at a minimum distance of X mm from the side of the appliance. Any wall units installed above the appliance's worktop must be positioned at least Y mm from it.

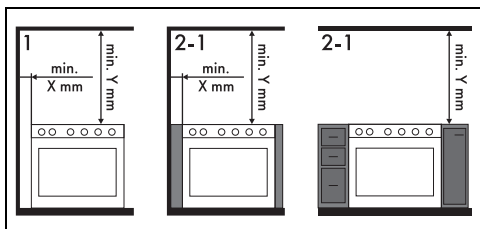

X 150 mm

Y 750 mm



If a hood is installed above the appliance, refer to the hood instructions manual to make sure the correct clearance is left.

Appliance overall dimensions

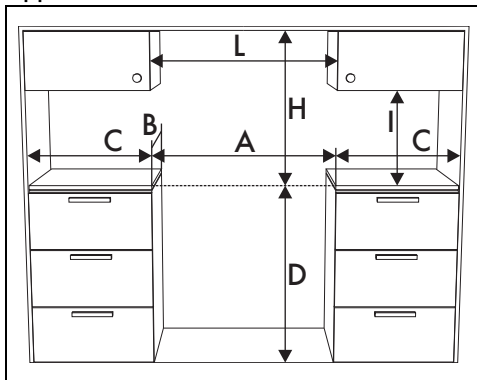

A	903 mm
B	600 mm
C ¹	min. 150 mm
D	898 - 920 mm
H	750 mm
I	450 mm
I ²	903 mm

¹ Minimum distance from side walls or other flammable material.

² Minimum cabinet width (=A)

Appliance dimensions

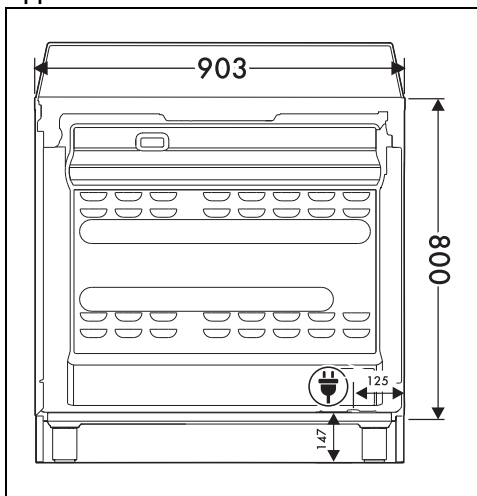

Position of electrical connection

Levelling the appliance



See General safety instructions.

The appliance must be level on the floor in order to ensure greater stability.

After making the gas and electrical connections, screw on the four legs supplied with the appliance (1). Screw or unscrew the feet at the bottom until the appliance is stable and level on the floor (2).

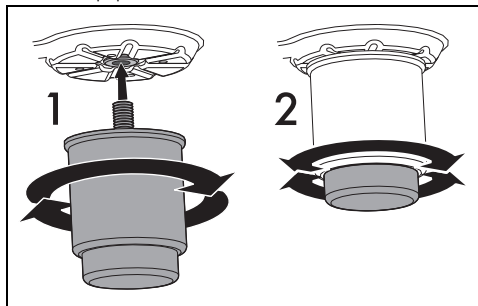

Assembling the upstand

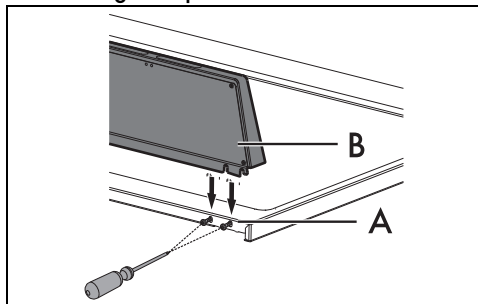

The upstand must always be positioned and secured correctly on the appliance.

1. Loosen the 6 screws (A) on the back of the hob using a screwdriver.
2. Place the upstand on the hob.
3. Align the slots of the upstand (B) with the screws (A).



The upstand provided is an integral part of the product. It must be fastened to the appliance prior to installation.

Fastening to the wall

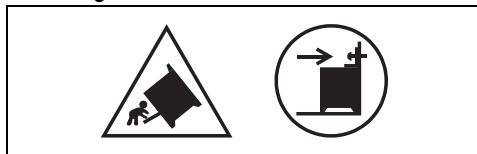

The symbols above indicate the danger if the anti-tip are not installed devices and the importance of their correct installation.



The anti-tip devices must be installed in order to prevent the appliance from tipping over.

1. Screw the wall fastening plate to the rear of the appliance.

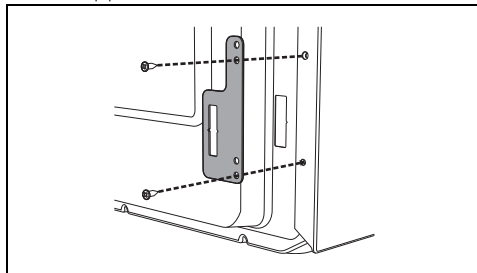

2. Adjust the height of the 4 legs.
3. Assemble the fastening bracket.

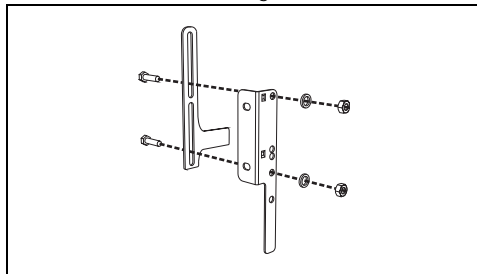

4. Align the base of the hook on the fastening bracket with the base of the slot on the wall fastening plate.

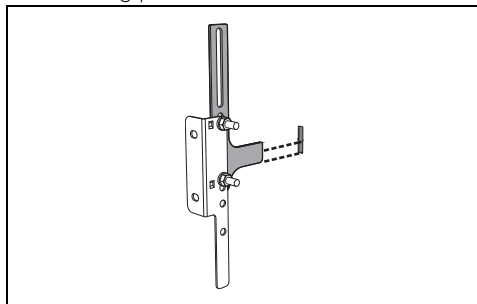

5. Align the base of the fastening bracket with the ground and tighten the screws to fix the measurements.

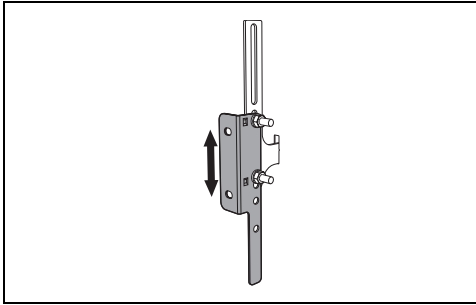

6. Consider a distance of 50 mm from the side of the appliance to the bracket holes.

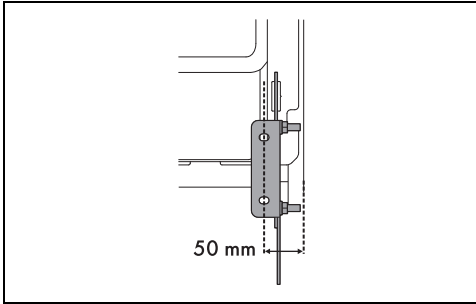

7. Move the bracket onto the wall and mark the position of the holes to be drilled in the wall.

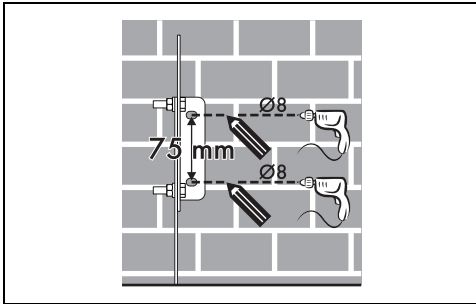

8. After drilling the holes in the wall, use wall plugs and screws to fasten the bracket to the wall.

9. Push the cooker towards the wall, and at the same time insert the bracket in the plate fastened to the rear of the appliance.

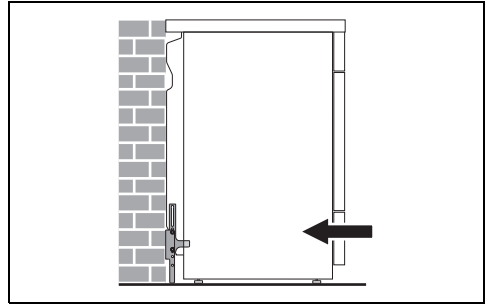

Electrical connection



See General safety instructions.

General information

Check the mains characteristics against the data indicated on the plate.

The identification plate bearing the technical data, serial number and brand name is visibly positioned on the appliance.

Do not remove this plate for any reason.

The appliance must be connected to ground using a wire that is at least 20 mm longer than the other wires.

The appliance can work in the following modes:

220-240 V 1N \sim

3 x 10 mm²
three-core cable

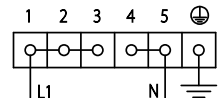

220-240 V 2 \sim

3 x 10 mm²
three-core cable

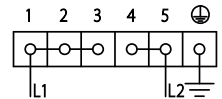

220-240 V 3 \sim

4 x 4 mm²
four-core cable

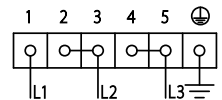

380-415 V 2N \sim

4 x 4 mm²
four-core cable

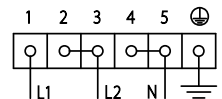

380-415 V 3N \sim

5 x 1.5 mm²
five-core cable

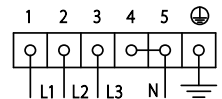



The values indicated refer to the cross-section of the internal conductor.



The aforementioned power cables are sized taking into account the coincidence factor (in compliance with standard EN 60335-2-6).

Replacement clamp

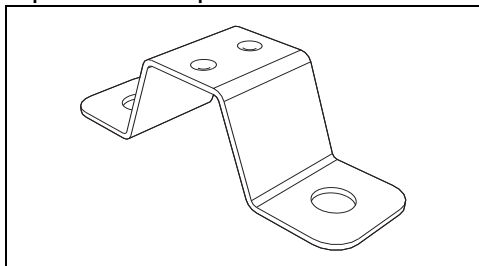

When connecting using a 10 sq. mm internal section cable, the existing clamp must be replaced with the one supplied in order to ensure that the cable is secured correctly.

Fixed connection

Fit the power line with an all-pole circuit breaker with a contact separation distance sufficient to provide complete disconnection in category III overvoltage conditions, pursuant to installation regulations.

For the Australian/New Zealand market:

The circuit breaker incorporated in the fixed connection must comply with AS/NZS 3000.

Accessing the terminal board

To connect the power supply cable, you have to access the terminal board on the rear casing

1. Remove the screws fastening the plate to the rear casing

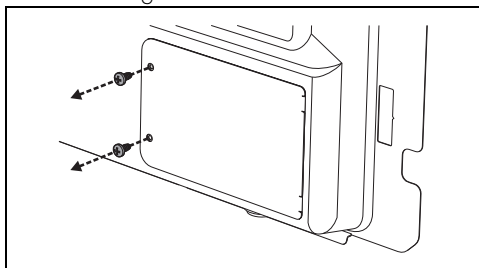

2. Gently rotate the plate and remove it from its seat.

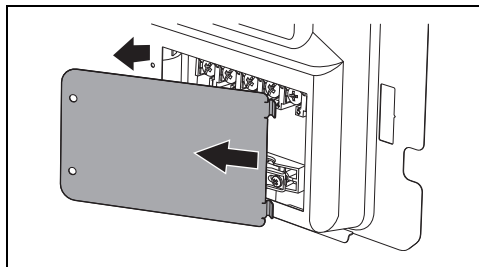

3. Proceed with installation of the power supply cable.

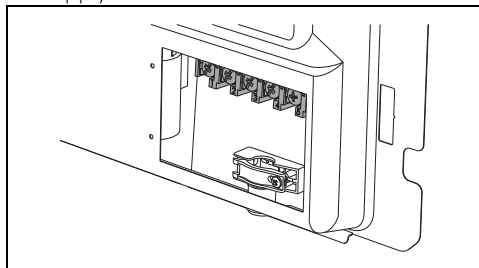

It is recommended to slacken off the cable clamp screw before installing the power supply cable.

4. When finished, replace the plate on the rear casing and secure it using the screws that were previously removed.

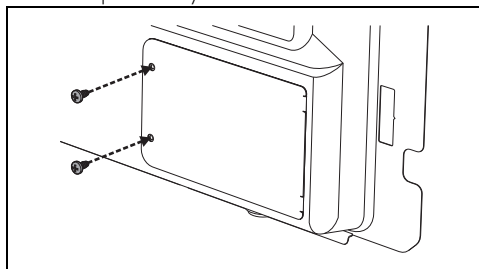

Instructions for the installer

- If you use a plug (if present) to connect to the power supply, the plug must be accessible after installation.
- Do not bend or trap the power cable.
- The appliance must be installed according to the installation diagrams.
- If the appliance does not work correctly after having carried out all the checks, contact your local Authorised Service Centre.
- Once the appliance has been installed,

please explain to the user how to use it correctly.